



Ropes Courses - Adventure Parks - Net Parks - Zip Lines - Simulated Freefall Devices

# THE UK ROPES COURSE AND OFF-GROUND ADVENTURE ACTIVITIES GUIDE 2021

For those involved in the design, construction, operation, inspection and maintenance of ropes courses and other off-ground adventure activities.



**AAIAC**  
Adventure Activities  
Industry Advisory Committee

**European  
Ropes  
Course  
ERCA Association**



<b>1. Foreword</b>	<b>6</b>
1.1 AAIAC.....	6
1.2 The European Ropes Course Association (ERCA) .....	7
<b>2. Abbreviations</b>	<b>8</b>
<b>3. The relationship between The Health &amp; Safety at Work Act, regulations, standards, ACOPs and guidance</b>	<b>9</b>
3.1 The Health & Safety at Work etc. Act 1974 (HSWA).....	9
3.2 Regulations.....	9
3.3 Approved Codes of Practice .....	9
3.4 Guidance from The Health and Safety Executive (HSGs) .....	9
3.5 Standards.....	9
3.6 Guidance from the industry.....	9
<b>4. What is a European Standard (EN)?</b>	<b>10</b>
4.1 Why use it? .....	10
4.2 How to read a standard.....	10
4.3 BSI, Standards and leaving the European Union.....	11
<b>5. General</b>	<b>12</b>
5.1 EN 15567-1:2015+A1:2020 an explanation.....	12
5.2 Low ropes and assault/obstacle courses .....	12
5.3 Net parks.....	13
5.4 Key terms / definitions from EN 15567 .....	13
5.5 Levels of supervision .....	15
5.6 Safety systems as defined by EN 15567.....	17
5.6.1 Assisted belay safety system.....	17
5.6.2 Individual safety systems.....	18
5.6.3 Collective safety system .....	20
5.6.4 Low ropes (spotting).....	20
5.6.5 Zip lines.....	21
5.7 Hazards and risks.....	23
<b>6. Construction</b>	<b>24</b>
6.1 Low ropes courses.....	25
6.2 Temporary ropes courses .....	25
6.3 New courses .....	26
6.4 Existing off-ground adventure activities course and modifications.....	26
6.5 Documentary obligations on constructors .....	26
6.6 Documentary obligations on operators.....	27
6.7 Obligations on participants.....	27
<b>7. Inspections &amp; maintenance</b>	<b>28</b>
7.1 Inaugural inspections.....	29
7.2 Periodical inspections.....	29



7.3	Operational inspection .....	30
7.4	Routine visual check .....	30
7.5	Tree inspections.....	31
7.6	Maintenance .....	31
7.7	Work at Height Regulations 2005 (WAHR) and inspections .....	31
<b>8.</b>	<b>Operation</b>	<b>33</b>
8.1	Good practice .....	33
8.2	Identification of appropriate instructor competence .....	33
8.3	Instructor induction .....	34
8.4	Instructor training .....	34
8.5	Identification of group competence.....	34
8.6	Acknowledgement of risk.....	35
8.7	Identification of element options .....	35
8.8	Human error accidents .....	35
8.9	Equipment.....	38
8.10	Weather forecast .....	39
8.11	Number of participants per element.....	39
8.12	Participant's morphology.....	39
8.13	Briefings.....	40
8.14	Use of adult supervisors .....	41
8.15	Assessment of participants' understanding of the rules and ability to operate their safety system.....	42
8.16	Technical advice .....	42
8.17	Recognised certification schemes and auditing your operation .....	44
	8.17.1 Adventure Activities Licensing Authority (AALA) .....	44
	8.17.2 Adventuremark .....	44
	8.17.3 ERCA – European Ropes Course Association .....	45
	8.17.4 Other ways to audit your operation .....	45
8.18	Medical conditions and/or disabilities.....	45
8.19	Manual handling.....	45
8.20	First aid.....	45
8.21	Emergency action plan.....	45
8.22	Off-elements supervision.....	46
8.23	Fire risk .....	46
8.24	Individual safety systems and the 'double unclipping' problem .....	46
8.25	Selecting competent suppliers.....	48
<b>9</b>	<b>References and further reading</b>	<b>50</b>
	<b>Appendix A 16th February (revised 2020) Statement by the Adventure Activities Licensing Authority in relation to Licensed establishments using ropes courses</b>	<b>51</b>
	<b>Appendix B Procedures for submitting comments on this guidance</b>	<b>51</b>
	<b>Photo credits</b>	<b>52</b>
	<b>Thanks</b>	<b>52</b>

*Image copyright is owned by the person and/or company and must not be copied or distributed in any way without prior permission.*



# EXECUTIVE SUMMARY

## Who is this guidance for?

This guidance is for those involved in the design, construction, operation, inspection and maintenance of ropes courses and other off-ground adventure activities. The intention is to help those involved in this industry to comply with EN 15567 and provide general advice on accepted good practice.

## About this guidance

EN 15567 sets out the standards to be met for the installation of new ropes courses and the operation of both new and existing ropes courses. All operators, designers, constructors and inspectors of ropes courses and off-ground adventure activities should have access to a copy of both parts of the latest versions of EN 15567 as they contain detailed information beyond the scope of this guidance. Copies are available to purchase from the British Standards Institute (BSI).

This guidance summarises key information about:

- construction
- inspections & maintenance
- operation
- choosing suppliers

**This guidance is not a substitute for relevant UK laws, EN 15567 or the full set of ERCA Standards.**

This guidance was initially compiled in 2008 and then revised in 2015 by:

- Nick Moriarty - The European Ropes Course Association

In conjunction with:

- The Health and Safety Executive
- Adventure Activities Licensing Authority and Service
- Adventure Activities Industry Advisory Committee



This 2021 guidance and review has been completed by:

- Chris Proud - Adventure Activities Industry Advisory Committee
- Emma Bell - The European Ropes Course Association
- Steve Woods - The European Ropes Course Association

For the scope of this guidance, off-ground adventure activities are man-made/artificial structures that have a form of activity system, safety system and support system. This can include, but is not limited to, the following in developmental, educational and pay-to-play/recreational settings:

- traditional ropes courses
- adventure parks
- net parks
- zip lines
- simulated freefall devices (i.e. QuickFlight, Powerfan®)
- Bag Jumps

It is not intended for this document to cover climbing walls, via-ferrata or caving, be this on natural terrain or simulated artificial structures. However, the principles within this guidance may be informative and, in some case will be applicable, such as a venue that has a climbing wall as part of their overall offering or a provider that offers a via-ferrata experience that is run in a similar way to an adventure park. If you have these types of activities then it is recommended that in addition to this document you consider contacting the relevant bodies to seek up-to-date advice on safe operation, best practice, competent advice and qualifications for instructors. Those relevant bodies include:

### Climbing, Mountaineering and Via-Ferrata

- Mountain Training – The Awarding Body Network [www.mountain-training.org](http://www.mountain-training.org) ↗
- Association of British Climbing Walls [www.abcwalls.co.uk](http://www.abcwalls.co.uk) ↗
- British Mountaineering Council [www.thebmc.co.uk](http://www.thebmc.co.uk) ↗



- Mountaineering Scotland [www.mountaineering.scot](http://www.mountaineering.scot) ↗
- Mountaineering Ireland [www.mountaineering.ie](http://www.mountaineering.ie) ↗

### Caving and Mine Exploration

- British Caving Association <https://british-caving.org.uk/> ↗

Compliance with this guidance does not infer approval, endorsement or similar from any of the named contributors to this guidance and does not entitle any organisation to use their logos or similar identification or to give the impression of such.

This guidance is updated from time to time in light of practical experience and feedback from operators, designers, constructors and inspectors. Comments on the content are welcome, and the procedure for submitting comments can be found at **Appendix B.** ↗



## 1. Foreword

Following the publication of the European Ropes Course Standard (EN 15567:2007) in March 2008 and Working at Height Regulations (2005, as amended 2007), the Adventure Activities Industry Advisory Committee (AAIAC) and UK Members of the European Ropes Course Association (ERCA) produced a single document for UK operators, trainers, inspectors and constructors of off-ground adventure activities. The first edition of the UK Ropes Course Guide was published in 2008, and was reviewed and republished in 2015 following the update of EN 15567 the same year.

The industry has continued to grow and develop with an increase in zip lines (in number, size and complexity), net parks and recreational and pay-to-play facilities. As a result, AAIAC and ERCA agreed to update this guide in order to support the industry as it continues to expand.

Although the first UK ropes courses appeared around sixty years ago, the industry has flourished significantly in the last twenty-five years. Unlike most adventure activities, ropes courses did not evolve as a sport or a pastime; rather they were a tool for personal and team development. In this respect, they remain one of the most powerful tools for outdoor experiential learning and are used in this way the world over. The use of off-ground adventure activities as a recreational/pay-to-play experience has increased significantly in the last decade.

This guidance has been designed to support both recreational and developmental use of ropes courses and off-ground adventure activities, recognising that although the activity structures may look similar, how they are utilised and operated can be very different.

All those involved in the design, construction, operation and inspection of ropes courses and off-ground adventure activities must comply with the Health and Safety at Work etc. Act 1974 and all relevant regulations.

Despite the high potential for risk, there is no specific regulation for the operation of off-ground adventure activities facilities in the UK. EN 15567 is a successful attempt to collate good working practice from across the European Union. Additionally, ERCA has been instrumental in collating good ropes course and off-ground adventure activities practice and accident data, and it remains at the forefront of industry developments.

### 1.1 AAIAC

AAIAC is responsible for the development, and the quality control inspection services for Adventuremark. It oversees the Adventuremark and LOtC Quality Badge for Adventure Activities accreditation and provides expert advice to the Health and Safety Executive (HSE) on numerous matters.

The members are selected and are representative of a wide range of stakeholders from the UK adventure activities sector including mountain guides, operators, inspectors and suppliers both from the private and public sectors. The body came about in 1996 to act as expert advice to the HSE when the Licensing Authority was formed.

AAIAC has been reconstituted to provide accountability to a UK-wide range of outdoor organisations called Adventure UK (AUK) and thus acts as the working arm on projects convened by AUK.

AUK was formerly known as the Adventure Activity Advisory Council, which merged with the UK Adventure Industry Group in 2019 to form the new body, which is made up of relevant organisations within the industry. AUK meet annually to receive an annual report and to provide direction, guidance and support on AAIAC's work plan. AAIAC has 10 members at any one time, each serving a minimum of 3 years.

There are also numerous working groups, looking at specific areas and AAIAC meets quarterly to review and plan current and future works.



## 1.2 The European Ropes Course Association (ERCA)

**ERCA** started in 1998 as a German association to work on standards and provide a platform (networking and exchange) for people working with ropes courses to increase safety and quality.

The success achieved through standards development resulted in an increase in the number of international members due in large part to there being no effective option for professional representation in their own countries and regions. So in 2003 the decision was taken to embrace other European countries, and the association became known as the European Ropes Course Association (ERCA).

The Association includes operators, trainers, builders and inspectors of ropes courses and off-ground adventure activities as well as organisations working with temporary or stationary ropes courses. The board and working groups represent the interests of all ERCA members and aim at further developing ropes courses.

At least once a year, a general meeting takes place offering the opportunity to set standards, to give the working groups assignments, to define new groups and to organise workshops and conferences dealing with our topics.

Since 2003 the UK membership of ERCA has continued to grow with many taking active lead roles in all aspects of ERCA and the industry here in the UK. ERCA and its UK members offer UK advice, support and events specific to the needs of our fast-growing industry.

ERCA has more than 325 members (company members + individuals) from around 26 countries and the community meets once or twice a year.

There are around 50 UK members, and if you would like to join please visit [www.erca.cc](http://www.erca.cc) ↖



## 2. Abbreviations

Solely for the ease of reading, the following abbreviations have been used in this guidance.

Full Name	Abbreviation
The Adventure Activities Licensing Authority	AALA
Adventure Activities Licensing Regulations	AALR
Adventure Activities Industry Advisory Committee	AAIAC
Adventure UK	AUK
Approved Code of Practice	ACOP
Amusement Device Inspection Procedures Scheme	ADIPS
The British Standards Institution	BSI
Conformité Européenne	CE
Comité Européen de Normalisation - European Committee for Standardisation	CEN
Comité Européen de Normalisation - European Committee for Electrotechnical Standardisation	CENELEC
Construction (Design and Management) Regulations	CDM
Continuous Professional Development	CPD
Deutsches Institut für Normung - German Institute for Standardisation	DIN
Environmental Health Officer	EHO
European Norm	EN
European Ropes Course Association	ERCA
Health and Safety	H&S
Health and Safety Executive	HSE

Full Name	Abbreviation
Health & Safety Guidance	HSG
Health and Safety at Work	HSW
Health and Safety at Work etc. Act	HSWA
International Electrotechnical Commission	IEC
Industry Guidance	INDG
International Organisation for Standardisation	ISO
Learning Outside the Classroom	LOtC
Lifting Operations and Lifting Equipment Regulations	LOLER
Management of Health and Safety at Work Regulations	MHSWR
Manual Handling Operations Regulations	MHOR
Mobile Elevating Work Platform	MEWP
Off-Ground Adventure Activity(ies)	OGAA
Personal Protective Equipment	PPE
Provision and Use of Work Equipment Regulations	PUWER
Reporting of Injuries, Diseases and Dangerous Occurrences Regulations	RIDDOR
Royal Society for the Prevention of Accidents	ROSPA
United Kingdom	UK
United Kingdom Accreditation Service	UKAS
United Kingdom Conformity Assessed	UKCA
Work at Height Regulations	WAHR





## 3. The relationship between The Health & Safety at Work Act, regulations, standards, ACOPs and guidance

The status and relationship between the Health & Safety at Work Act, regulations, standards, ACOPs and guidance has been a longstanding source of confusion in the industry and elsewhere.

### 3.1 The Health & Safety at Work etc. Act 1974 (HSWA)

The primary health and safety legislation that governs what we do, both in relation to employees and non-employees (e.g. contractors, customers and other members of the public) is the HSWA.

### 3.2 Regulations

Health and safety regulations (secondary legislation), like the HSWA, impose legal requirements on duty holders. They are enforced by authorities like the HSE and local authorities. Examples of regulations applicable to our industry include the MHSWR, WAHR and PPE at Work Regulations, 1992.

### 3.3 Approved Codes of Practice

Information intended to assist duty holders in understanding their legal duties can be found in ACOPs and guidance. ACOPs are published by the HSE. They have a special legal status created by the HSWA Section 17 *'If a duty holder is prosecuted, and it is proved that they have not followed the relevant provisions of the ACOP, a court can find them at fault unless they can demonstrate compliance with the Law by some other means.'*

### 3.4 Guidance from The Health and Safety Executive (HSGs)

These documents are headed with the initials HSG & INDG and are designed to give technical advice and to help you interpret and comply with the law. Following guidance is not compulsory. Duty holders are free to take other action. However, if you follow guidance, it is reasonable to assume that you are doing enough to comply with the law.

### 3.5 Standards

British Standards are not sources of law. Consequently, duty holders are not legally obliged to follow them. However, like guidance a standard may be relied upon as a bench-mark against which the conduct of the duty holder will be measured. EN 15567 parts 1 and 2 are not the law, they are standards, but ones that you could potentially be measured against as part of evidence should there be an accident, serious incident or visit from the HSE or your local EHO.

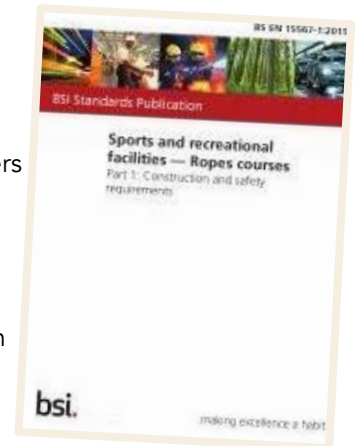

It should also be made clear that the requirements of EN 15567 are not the benchmark of good practice. They are considered the lowest level of safety or the starting point of safety and quality.

Following EN 15567 does not necessarily mean duties required by law have been met. It does not absolve duty holders of the need to comply with their duties under the HSWA and health and safety regulations.

### 3.6 Guidance from the industry

Guidance is also published by industry bodies. Prominent examples are the ERCA Standards and the UK Ropes Course Guide, neither of which are published by the HSE. However, if a duty holder is prosecuted for a material breach of their health and safety duties, the enforcement authority may place reliance upon the relevant provisions of industry guidance to prove the duty holder has fallen short of the standard required in the circumstances.



## 4. What is a European Standard (EN)?

The following is taken from <https://www.cencenelec.eu/>; 

*'Standards are all around us, even if we are not always aware of them. One example of a widely-used standard is the A4 size for sheets of paper.'*

*Standards are developed and defined through a process of sharing knowledge and building consensus among technical experts nominated by interested parties and other stakeholders - including businesses, consumers and environmental groups, among others.*

*The formal definition of a standard is a "document, established by consensus and approved by a recognized body, that provides, for common and repeated use, rules, guidelines or characteristics for activities or their results, aimed at the achievement of the optimum degree of order in a given context".*

*Standards are voluntary which means that there is no automatic legal obligation to apply them. However, laws and regulations may refer to standards and even make compliance with them compulsory.'*

In 2003, Germany initiated the EN 15567 in an attempt to formalise standards across the sector. UK representation on the committee of experts, was poor initially but by the end of the process the UK had its interests represented proportionately and the CEN committee elected a UK expert (Nick Moriarty) as Convenor.

- EN 15567:2008 endeavoured to strike a balance between very different (national) cultures.
- EN 15567:2015 was more comprehensive and accurately reflected, what had become, a united European industry.
- EN 15567-2:2015 relates to the operations and remains largely subjective.
- EN 15567-1:2015+A1:2020 relates to the construction and safety requirements, and is objective and measurable.

### 4.1 Why use it?

Put simply, would you trust a harness or a karabiner that was not compliant with the appropriate standard? Apply that same professional approach to your off-ground adventure activities and understand that your facility conforms with EN 15567 when you have met all its parts, clauses and requirements.

### 4.2 How to read a standard

EN 15567 is designed to be used by competent persons, meaning if you don't understand it, get some help and advice. The MHSWR reg7 Health and Safety Assistance states that employers must have access to competent persons to assist them in applying the provisions of health and safety law **(see section 8.16 Technical Advice)**. 

It is advisable to read and understand all of it, not just the main clauses. Read the introduction,

the scope, other standards that are relevant in their application, definitions, clauses and annexes (Normative and Informative).

Without understanding all of the standard you may be applying it incorrectly and failing to fully meet all of your duties. Whether you are the designer, constructor, inspector, owner or operator, understanding the language within EN 15567 is also important. In order to make it clear, the following (with some examples) verbal forms are used:

- Requirements – **shall, shall not**
  - » A.3 Requirements for inspection bodies (Type C)
  - » The inspection body shall provide safeguards within the organisation to ensure adequate segregation of responsibilities and accountabilities between inspection and other activities.





- » b) The design/manufacture/supply/installation/servicing/maintenance and the inspection of the same item carried out by a Type C inspection body shall not be undertaken by the same person. (Examples from ISO 17020)

- Recommendations – **should, should not**

- » 10.4 Periodical inspection
- » Periodical inspections should be carried out at least each calendar year and with a maximum interval of 15 months by an inspection body (type A, type B or type C in accordance with EN ISO/IEC 17020:2012, Annex A). (Example from EN 15567)
- » A report containing the following information shall be prepared as part of the periodical inspections:
  - » h) a statement that the inspection report should not be reproduced, except in full. (Example from EN 15567)

- Permissions – **may, need not**

- » It is recognised that application of every provision of this standard may not be appropriate in all circumstances. Any deviation from the standard should provide an equal or greater level of safety. When deviating from the standard, a written risk assessment setting out the rationale for the deviation should be provided. (Example from EN 15567)

**NOTE:** *The inspection body need not be the owner of the facilities or equipment that it uses for the inspection. Facilities and equipment may be borrowed, rented, hired, leased or provided by another party (e.g. the manufacturer or installer of the equipment). However, the responsibility for the suitability and the calibration status of the equipment used in inspection, whether owned by the inspection body or not, lies solely with the inspection body. (Example from ISO 17020)*

- Possibility and capability – **can, cannot**

- » Safety systems can be collective or individual. Individual safety systems are classified in categories A to E. However, these categories do not in themselves determine the safety of the ropes course. The various safety devices consist



of equipment designed to limit the consequences of falls or collisions. There are inherent risks associated with ropes courses. These risks, however, should be appropriately managed and minimized by the ropes course operator and their staff; it should be understood that the risks cannot be eliminated altogether. (Examples taken from EN 15567:2015-2)



### 4.3 BSI, Standards and leaving the European Union

The UK, through the British Standards Institution (BSI) has been a member of the CEN and CENELEC for decades, playing a lead role in designing and influencing harmonised standards for all industries and the safe manufacture and supply of products.

As the ropes course standard does not carry any conformity or safety certification requirements, there will be no change to the standard or how it is employed here in the UK. The UK, through the BSI, will continue to adopt, work on and review the standard moving forward.

For information on how safety certification is changing in the UK as we move away from the CE to the new UKCA mark, please visit the **government**  or the **BSI website**  as they publish updates.



## 5. General

Compliance with this guidance and EN 15567 are not legal requirements. However, they may be referred to by the health and safety enforcing authorities when considering how a company or self-employed person has discharged their health and safety duties.

Therefore, it is important that those involved in the design, construction, operation, inspection and maintenance of ropes courses and other off-ground adventure activities are familiar with this guidance as well as EN 15567.

In addition, if you operate a large zip line, giant swing, bag jump, net park or choose to run your activities in a similar way to an attractions business or pay-to-play recreational model, then you may also wish to familiarise yourself with the following health and safety guidance;

- **HSG 175 Fairgrounds and amusement parks: Guidance on Safe Practice** 

### 5.1 EN 15567-1:2015+A1:2020 an explanation

In 2018/19 there was an amendment requested by the German standards committee (DIN), the German version of the BSI. The committee asked for a very small change to the requirements of clause 7.1.2 Inaugural inspection in Part 1 of the 2015 standard. One sentence was moved but was kept within the clause, and there was the addition of 1 new word, which was to document the findings of the inspection.

Other than this very small amendment, A1:2020 is the same as 1:2015

Part 2 was not amended, so at the time of publication of this guidance the two relevant parts of EN 15567 are:

- EN 15567-1:2015+A1:2020
- EN 15567-2:2015

### 5.2 Low ropes and assault/ obstacle courses

EN 15567 does not seek to differentiate between high and low courses, but when writing EN 15567, the main focus was on high ropes activities, zip lines and adventure parks. Generally, a high ropes course will rely on an assisted belay, collective or individual safety system (see Diagram 1 on page 13).

A low ropes course is the generic term for elements close to the ground (generally within 1 metre) that are protected by a combination of spotting

from the instructor or other group members and the ground covering acting as an impact-absorbing surface. How these 2 safety systems function together and to what extent they will offer protection from a fall will be different at each venue and often different for each individual low rope activity. The term low ropes may also include an assault/obstacle course and initiative exercises.

Initiative exercises are generally single challenges that require team participation and, as the name implies, the emphasis is placed on participants using their initiative. Many of these will be simple, temporary, ground-based tasks and as such will not be covered by EN 15567 or this guidance.

An assault/obstacle course is a series of free standing or linked elements where the emphasis is normally on it being a physical challenge (team or individual). With the growth in obstacle course racing and mass participation events, there is work being carried out to write a set of International Standards for these type of activities. When this work has been completed it may be better to refer to these standards and not EN 15567 or





this guidance if you are designing, constructing, inspecting or operating an assault/obstacle course.

**Note:** EN 15567:2015 specifically included zip lines, due to their rapid growth, and expansion and this guide is applicable to these types of activities.

### 5.3 Net parks

Since 2015 net parks have increased in popularity and although not specifically mentioned in EN 15567 are considered by many industry professionals to be a collective safety system. On that basis you may choose to apply EN 15567 and this guidance to your net parks.

Alternatively, you may define your net park as a playground, and as long as this is the way you are operating it, then BS EN 1176 Playground Equipment and Surfacing may be a more appropriate standard to follow.

The decision will depend on many factors and the earlier in the process of designing a new net park you make that decision, the better. Designing, owning and operating a net park as a piece of playground equipment is very different to designing, owning and operating a net park as a piece of off-ground adventure activity equipment.

To help you make these decisions you will need to ensure you have competent advice. Following a Design Risk Assessment process early on in the project may lead you to the correct EN.

## 5.4 Key terms / definitions from EN 15567

### Ropes Course

Constructed facility consisting of one or more activity systems, support systems and, if needed, belay and/or safety systems with restricted access and requiring supervision.

#### Key to diagram 1 below:

Activity Systems include:

- A1 Elements
- A2 Platforms
- A3 Access

Support Systems include:

- S1 Poles, trees, buildings, rock or other supporting structures
- S2 Foundations, anchors
- S3 Guy Lines

Belaying Systems include:

- B1 Assisted Belaying System
- B2 Safety line
- B3 Individual Safety System (categories A to E)

**Diagram 1:** Example of a ropes course

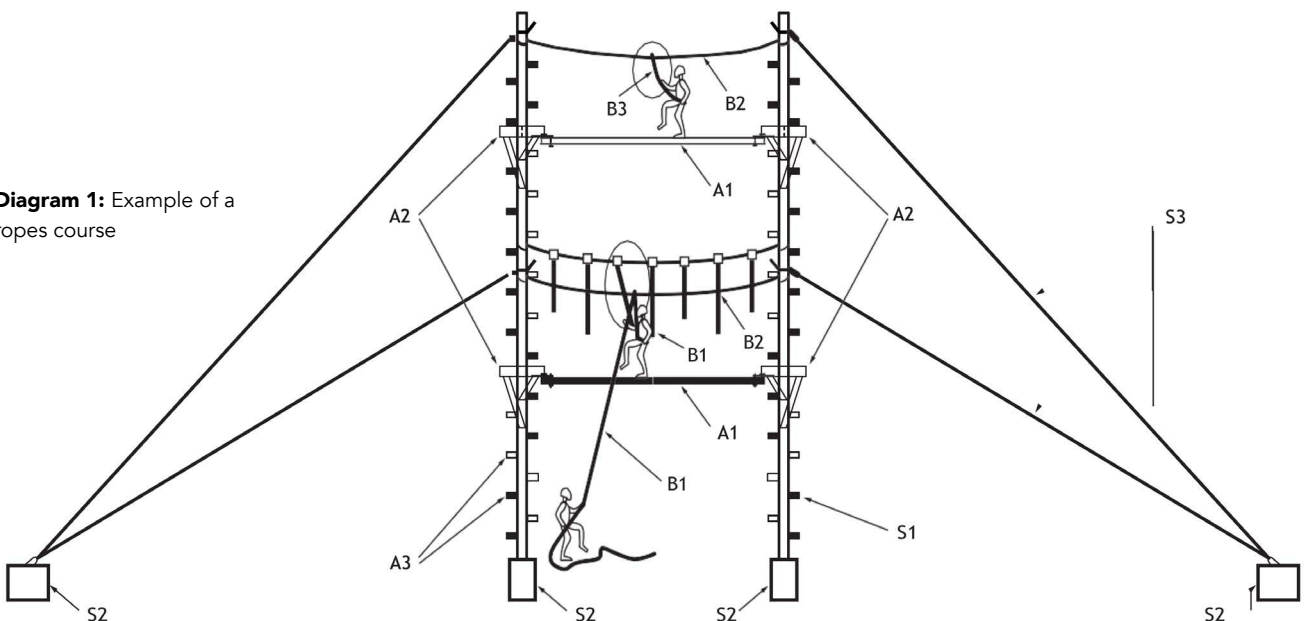

### Assisted belay system

Belay system where the participant is secured by at least one person. For example, a top rope belay system.

### Individual safety system categories A-E

Component(s) connecting the harness to the safety line (see examples for each later below).

- **Category A** - Self-closing device which is not automatically self-locking. Examples include self-closing or screwgate karabiner.
- **Category B** - Self-locking device. Examples include self-locking karabiners.
- **Category C** - Interlocking device to reduce the likelihood of unintentional detaching from the safety system.
- **Category D** - Interlocking device to prevent unintentional detaching from the safety system. When used in accordance with the manufacturer's instructions this technology can significantly reduce the levels of training, supervision, information and/or instruction required to maintain appropriate levels of operational safety.
- **Category E** - Device that is permanently attached, and can only be opened with a tool. When used in accordance with the manufacturer's instructions, this technology can significantly reduce the levels of training, supervision, information and/or instruction required to maintain appropriate levels of operational safety. NOTE: appropriate monitoring and rescue arrangements are still necessary.

### Collective safety system

System that can protect at least one person and once properly installed or erected, does not require any action by the user to make sure it will work.

### Interlocking device

Device with at least two gates whereby an action on the one gate results in an effect on another gate.

### Mobile off-ground adventure activities

Facility that is transportable.



### Supervising adult

Person aged 18 or above who is either the parent/legal guardian or has the authority of the parent/legal guardian of the child participant(s). To have undertaken adequate training in how to accompany and supervise the child participant(s) whilst taking part in the activity. They must also be in a position to maintain visibility of the child participant(s) and intervene verbally.

### Critical application

Application where the consequences of a failure are likely to lead to a serious injury or death.

### Primary brake

Active or passive braking system engaged during normal operation (of a zip line) to arrest the participant.

### Active braking system

Braking system (on a zip line) operated by the participant or another person.

### Passive braking system

Braking system (on a zip line) operating without manual intervention. Examples are bungee, gravity, net, water, impact absorbers, impact absorbent floors, landing mats, etc.





### Emergency braking system

Passive braking system (on a zip line) that controls participant deceleration upon failure of the primary brake without causing serious injury or death.

### Routine visual check

Inspection intended to identify obvious hazards that can result from vandalism, use or adverse weather.

### Operational inspection

Inspection, more detailed than routine visual inspection, to check the operation and condition of the equipment.

### Periodical inspection

Verification carried out by an inspection body at least once per calendar year and within a maximum interval of 15 months.

### Level 1 supervision

Where an instructor can physically intervene to prevent a misuse of the safety system or another incident that would otherwise lead to a significant risk of serious injury or death.

### Level 2 supervision

The instructor cannot physically intervene to prevent a misuse of the safety system or another incident that would otherwise lead to a significant risk of serious injury or death. However, they are in a position to see the participant and intervene verbally. Responsibility for safety is shared by the participant and the instructor.

### Level 3 supervision

Where a participant is in a position to alert an instructor of their need for assistance and where the instructor is able to respond promptly to the alert and provide adequate assistance. It is intended that the role of the instructor is to provide adequate assistance to a participant if called upon to do so. This is a largely reactive role on the part of the instructor; therefore, responsibility for safety is largely with the participant.

### Inspection body

A company or individual that carries out inaugural and periodic inspections. EN ISO/IEC 17020 defines inspection bodies as type A, type B and type C, which are covered by appropriate professional liability insurance. The classification A, B, C denotes the level of independence – not competence.

## 5.5 Levels of supervision

The levels of supervision described in EN 15567 were originally designed and written for application to ropes courses and adventure parks. However, the definitions and recommendations on differing levels of supervision are also deemed to be suitable and good practice for other off-ground adventure activities, including but not limited to, net parks, giant zip lines, 3G swings and jump bags.

Inevitably there is some crossover between the three levels of supervisions, but as a general rule those on an assisted belay ropes course will be under Level 1 supervision. The level of supervision required for other types of safety systems may well be set at a minimum level, but the management plan for the operator should have built into it the ability to be flexible on a day-to-day basis depending on a range of considerations including but not limited to:

- The information provided to participants before booking, at point of sale and also before taking part in the activity.
- The experience of participants.
- The needs of the participants.
- Any learning or educational goals.
- The experience of the instructors.
- The complexity of the specific safety system and the ability of the participants to use it competently.
- The weather conditions that day.
- The amount of instruction participants have received.
- The design of the off-ground adventure activity.





Safety is achieved through a combination of course design, course maintenance, technology, experience and instruction of the participants, supervision plans and competency of instructors. When this is done well, all three levels of supervision can provide for safe and rewarding experiences. However, any compromise in one area will require a proportionate enhancement in another.

Consider the levels recommended to be the starting point and minimum requirement. They should not be regarded as permission to operate at those levels. As with all operating decisions, the supervision plan should be based on risk assessment.

To explain it further, there may be crossover between the various levels of supervision. For example, an assisted belay ropes course activity may form part of a school's curriculum. As a result, students may participate on the ropes course every week for an entire school year. Initially they may be taught how to belay under very close supervision (Level 1 supervision), but as their experience and competence grows so

the requirement for high levels of supervision may diminish and Level 2 supervision or Level 3 supervision may be perfectly adequate. Similarly, and by way of example, those who have used a Category B Individual Safety System regularly may not, under certain circumstances, be required to begin with Level 2 supervision. Conversely, for example, a risk assessment for people with specific needs using a Category B Individual Safety System may well identify that increased supervision levels are required.

In short, one fixed model of how you supervise the participants taking part in your OGAA may not be suitable for all and there may, at times, be the need to be flexible and offer differing levels of supervision for certain groups or individuals.

Ratios of instructors to participants also needs careful consideration. Differences in the experience of instructors, participants, weather conditions, aims of the session and the demands of particular courses produce far more variation than can be adequately managed by a simple ratio. The only ratio within EN 15567 relates to those on an assisted belay ropes course activity where there is a requirement that an instructor should not be responsible for more than 4 people at height at any one time. In essence, this means that an instructor cannot supervise more than four belayers simultaneously under optimum circumstances of competence, experience, etc. It should be emphasised that this is a minimum ratio (contained within a minimum standard) and that for inexperienced participants a more conservative ratio (i.e., fewer belayers per instructor) should be adopted. Alternatively, the methods of supervision and the equipment used may mean that a high ratio, even with novice belayers, is acceptable.

Complete a risk assessment and design your supervision plan and operating supervision levels upon this. Use the levels as described in the standard as the minimum starting point and allow for flexibility in your plan. Finally, if necessary, seek competent advice.

If you operate with group bookings of under 18s and hold an AALA Licence for other activities, please refer to **Appendix A**  to this guide.

## 5.6 Safety systems as defined by EN 15567

### 5.6.1 Assisted belay safety system

An assisted belay system, such as the one in the photo, is simply a system where the participant is secured by at least one other person. This could be a bottom-top rope system such as those used at a climbing wall or a climbing crag where the belayer is stationed on the ground, and the rope is positioned above and then back down to the climber. The advantage of this system is that the climber can climb uninhibited without necessarily worrying about their own safety, as this is in the control of the belayer on the ground. When supervised and used correctly, this system offers low risk of a fall to the climber but good opportunity for learning development, as those climbing will rely on the support, both physical and emotional, from those belaying on the ground.

You do not need to use belay devices as part of the system. Nor do you need to use ground anchors as a means to secure the belayer to the ground, either tested or untested. There are many options and all can be utilised and performed safely. Here are some other options for protecting the participants on an assisted belay ropes course.

#### The Australian Belay/team belay method



#### PGL Set up for team belaying



When choosing an assisted belay safety system, the questions to ask are:

- ? Has the chosen system been designed appropriately by a competent person for your groups and how you wish to operate?
- ? Do your instructors know how to use the system correctly, including its limitations?
- ? Have instructors been trained how to teach novice belayers?
- ? Have instructors been trained how to supervise novice belayers, as well as the climbers?

There can be advantages to removing a device that requires specific belaying skills and moving to a belay system that brings the human element back into the course programme.

Whatever system you use or wish to consider, do not just copy what others are doing. Seek competent advice about how to use the system correctly, and then ensure your staff team are trained in its limitations, how to use it safely and how to teach and supervise novices.





## 5.6.2 Individual safety systems

Individual safety systems now have a specific safety standard that was officially **published** in March 2020.

**BS EN 17109:2020** Mountaineering equipment. Individual safety systems for rope courses. Safety requirements and test methods.



You would not be expected to purchase a copy of this standard as an operator, but you should certainly insist that any system you are planning to have installed at your facility meets this standard. It may also be prudent to seek advice on your current system, and see if it is possible to update your system so that it can be certified to EN 17109:2020.

Individual safety systems are not just for recreational operators offering experiences to those who wish to take part in an adventure at height with family or friends. As with assisted belay ropes courses, the opportunity for self-discovery, trust and relationship building as well as many other developmental topics can be safely explored on a well-designed and appropriately supervised facility that is employing an individual safety system.

The first individual safety systems were often referred to as Cows Tails courses and were in use over 50 years ago. The participants were taught how to make their Cows Tails out of rope, sometimes even making their own harness. They would then work together to keep each other safe at height, after practising at a safe height or even on the ground. Ropes courses like this can be managed to meet the requirements of EN 15567. Their use, when appropriate for the people taking part, can be safe and in many parts of the world are still in use today.

EN 15567 categorises individual safety systems in the following way. It is not a list of least safe (A) to most safe (E). The standard uses the category system to help the designer or the operator of the course to consider supervision requirements/levels, briefing signage and signage on the course, ground training facilities for the participants, time needed for training and assessing of participants before they start their adventure.

All categories, when the course is designed appropriately and well, can be operated safely. As with a chosen method for an assisted belay system, you should not simply copy what others are doing but seek competent advice where necessary.

Understanding the categories will help when you read Part 2 of EN 15567. However, here is one clause in Part 1 that is critical to all categories and to meeting the requirements of EN 15567.

### 4.3.5.3.1 Use of connectors for attachment to the safety line

The use of individual safety systems categories A to D is restricted to the action of change over. All other connectors in the individual safety system shall only be openable with a tool. The only exception is when the connector is out of reach of the participants when a triple action connector may be used.

Here are the categories with some examples:

#### Individual safety system: Category A

Self-closing device which is not automatically self-locking. Examples include self-closing or screwgate karabiner. The use of individual safety systems category A is only allowed when all change-overs take place from a stable position of balance (e.g. on a platform), or a collective safety system is in place. Examples only:



**DMM Spectre**  
– “snap-gate”  
karabiner

**C.A.M.P. USA Inc HMS -**  
**Compact Lock Carabiner**



### Individual safety system: Category B

Self-locking device. Examples include self-locking karabiners. Examples only:



Petzl Vertigo



ISC Offset  
Oval triple action

### Individual safety system: Category C

Interlocking device to **REDUCE** the likelihood of unintentional detaching from the safety system. An 'interlocking device' is a device with at least two gates whereby an action on one gate results in an effect on another gate. Example only:



The Edelrid Smart Belay device is a category C system that is currently in use but will be phased out over the coming years.

### Individual safety system: Category D

Interlocking device to **PREVENT** unintentional detaching from the safety system. An 'interlocking device' is a device with at least two gates whereby an action on one gate results in an effect on another gate. Example only:



ISC Smart-Snap



CLIC-iT®



Edelrid Smart  
Belay X

### Individual safety system: Category E

Device that is permanently attached and can only be opened with a tool. Examples only:



Roperoller®



COUDOU Pro



Saferoller®



Nico Ltd

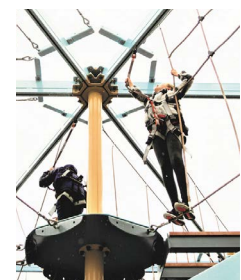

Ropes Course Inc.



### 5.6.3 Collective safety system

Collective safety systems include:

#### Net parks



### 5.6.4 Low ropes (spotting)







RockReef at Bournemouth Pier

### 5.6.5 Zip lines

Zip lines can now be found all over the UK, from the world famous Zip World, in North Wales to Bournemouth Pier and inside shopping centres.

Westfield Shopping Centre







**Emergency brake (e.g. spring covered by foam) must be passive**

**Primary (Passive) Brake. An appropriately prepared and maintained ground surface can provide the primary brake.**

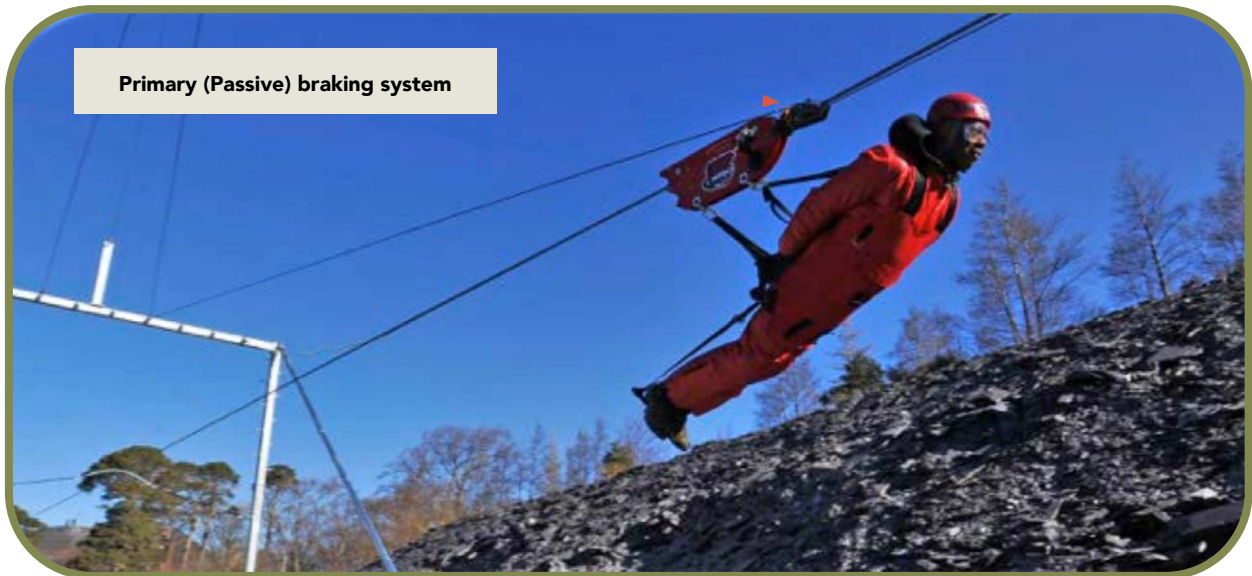

**Primary (Passive) braking system**



## 5.7 Hazards and risks

A hazard is something with the potential to cause harm, and a risk is a measurement that takes into account the likelihood and severity of harm from that hazard.

Owners and operators of ropes courses and off-ground adventure activities endeavour to create wonderful and life-affirming experiences for their customers. One would hope that nobody sets out to hurt another person; equally, it would be an impractical task to design an activity, in our industry, that was without risk altogether. The aim is to reduce the risk to the lowest practicable level by taking preventative measures. Health and safety legislation requires us to identify, and control hazards and risks in our operations.

The introduction in EN 15567 details some of the responsibilities of the constructors and operators of ropes courses and off-ground adventure activities and includes risk assessments. It acknowledges that there are some inherent risks associated with all ropes courses and off-ground adventure activities, and operators should make participants aware that these risks exist but through careful management they are tolerable.

When operating ropes courses and off-ground adventure activities under level 2 and 3 supervision the responsibility for the control of these risks, to some degree, becomes shared by the participants and the operators.

Operators should provide a well-built facility, safe equipment, appropriate supervision, information, instruction, training and assessment of the participants' understanding and ability to operate any equipment before they are allowed to take part in the activity. When participants have started their experience and are either out of reach or out of sight, the responsibility and the control of risk is now shared. The operator is very much relying on the participants to follow the rules and training they have received, use the equipment correctly, supervise each other and notify the supervising staff if there is a problem or they are in need of help.

This shared responsibility of risk should be made clear to anybody who wishes to take part no matter what the facility or level of supervision. Many recreational operators ensure participants complete an 'acknowledgement of risk' form.

They also inform the participants of the risks on arrival, during the safety brief and before taking part in the activities. For certain operations, all or more of these options may be prudent. The identification of risks should be clear and allow realistic, informed and uninhibited options to any participants, who, as a result, may wish to decline the activity. It is worth noting that, for some, the risks may not be truly apparent until a participant has seen or even started an activity. **See section 8.6 Acknowledgement of risk.** 

In addition to human error, which is covered in **section 8.8**  there are a variety of hazards that may be found on ropes courses and off-ground adventure activities. It is important to appreciate that no two facilities will have exactly the same hazards, and these may also vary with the different participants. Some common hazards found on ropes courses and off-ground adventure activities may include, but are not limited to:

- Connection errors between the harness and the safety system.
- Falling from an activity system to the ground.
- Falling, sliding or swinging into something solid (also common hazards on a low ropes course).
- Falling from one activity system onto another, or another part of the same.
- Objects dropped from a height.
- Rope burn - which may in turn lead to a more serious incident such as letting go of a belay rope.
- Entanglement in a rope or net – there may be a higher likelihood when helmets are worn.
- Hair, finger or clothing entrapment in nets or equipment like belay devices and zip trolleys.
- Lower limb injuries from bouncing on nets and when landing on zip lines.
- Collision between participants on net parks or zip lines.
- Zip line brake systems malfunctioning. When designing braking systems for zip lines consideration must be given to mitigating the consequences of failure. These should include if the system fails to stop the rider as designed and if the system jams and stops the rider abruptly, thereby imparting a dangerously high force on the rider and the equipment.





## 6. Construction

Traditionally, ropes courses were constructed by enthusiastic outdoor instructors, and the original Outward Bound™ courses were good examples of this. Typically, builders were climbers and often had some complementary skills such as a familiarity with sailing and associated hardware (e.g., rigging materials like shackles and cable). Courses were generally erected in trees, and the constructor was invariably responsible for operating the course, so they naturally understood how it was best managed safely.

As the commercial value of ropes courses became recognised, so construction techniques became more sophisticated and considered. Many courses are now built as freestanding structures, but they can also be found in disused mines and quarries, shopping centres, cruise ships and on top of skyscrapers.



Inevitably these structures are a far cry from the early courses. They are now highly engineered and use a diverse range of modern materials and techniques in the construction. Some zip lines can reach up to 1.7 miles long, and there are adventure activity parks with upwards of a 100,000 users per year.

In the design phase of your project, you may want to consider whether you should follow the advice and guidance of HSG 175 and the ADIPS inspection scheme, in addition to EN 15567 and the ERCA Standards. This is particularly relevant to operators who would primarily consider themselves to be an amusement park or visitor attraction. It is beyond the scope of this guidance to fully explain these established routes to design, construction and inspection. For more information, please use the following web links:

- <https://www.hse.gov.uk/entertainment/fairgrounds/adsc.htm> ↗
- <https://adips.co.uk/> ↗

### The Construction (Design and Management) Regulations 2015

Whichever route to construction you decide to take, you will always need to consider CDM, as it imposes specific duties on designers and others during the pre-construction phase of a project. For detailed guidance on CDM you can refer to the **CDM ACOP L153** ↗ as well as the short guide **INDG 411** ↗



**Note:** It is worth noting that the effectiveness of pole treatment (timber preservation) has declined since 2004 following the introduction of various European restrictions that prohibit the use of certain chemicals and procedures previously adopted. Timber poles that may previously have provided upwards of 25 years' safe use may now have a far shorter 'lifespan'. Meticulous inspection by a competent person is therefore very important. There have been a number of very serious pole failures in recent years. It is very difficult to determine how well a pole has been treated. In the UK, suppliers to the telecommunication and electrical industries are normally able to provide poles conforming to the highest standards, but due to issues in the past, most are unlikely to offer any form of warranty on the poles.

There are also a number of supplementary preservative treatments that can be applied before and after installation, such as pole-saver sleeves and a variety of chemicals which can significantly enhance pole longevity. Additionally, most professional constructors are now mounting poles above ground or utilizing an all-steel structure. Specialist advice should be sought.

## 6.1 Low ropes courses

EN 15567 does not specifically reference low ropes courses. Appropriate care should be taken in ensuring that a low ropes course is structurally sound, that landing areas and surfaces are suitable and that they are operationally fit for purpose. It would of course be inappropriate to expect a constructor of a 'spider's web' to provide engineering design calculations; however, it would be very important for the operator of a 'spider's web' to be in possession of instructions from the constructor on how the activity should be run. An inaugural inspection as defined in EN 15567 is not a requirement for low ropes courses, but many still choose to have this inspection as part of their safety management system.

## 6.2 Temporary ropes courses

People have been building and creating ropes course activities for decades. In order to construct and use a temporary ropes course you need:

- trees of sufficient size
- the ability to assess the trees you wish to use
- knowledge of which parts of the trees to use
- knowledge and equipment to build the activities then you can, temporarily, build your ropes course.

EN 15567 defines a temporary ropes course as being in place for less than 7 days and significantly does not consider temporary ropes courses to include mobile ropes courses.

It also states in the scope that Part 1 of the standard does not apply to temporary ropes courses. Part 2 does apply and both parts apply to mobile courses. The easiest way to distinguish between a mobile and temporary ropes course is that every time you erect a mobile ropes course it will be essentially (materially) the same, no matter where it is located. However, a temporary ropes course can be different every time it is built.

**Mobile ropes course before it is erected**



**Mobile ropes course, erected and in use**

**Part of a temporary low ropes set-up**



**ERCA UK Training Bodies coming together to train to be temporary low ropes instructors & constructors**

If the idea of building a temporary ropes course is something you would like to explore for your operation or outdoor activity centre, or you are already doing so, then you must ensure you get competent advice on tree selection, equipment/materials for the build, techniques and tools needed and finally methods to ensure the build is safe before use.

To support operators, ERCA has a series of Temporary Ropes Course Constructor and Instructor training courses. For more information on these, contact ERCA at [www.erca.cc](http://www.erca.cc) ↗



### 6.3 New courses

The construction of any new ropes course and off-ground adventure activities should be in accordance with EN 15567. It may also be appropriate for your activity to be built in accordance with HSG 175.

### 6.4 Existing off-ground adventure activities course and modifications

The date when your course was built or significantly modified, will determine which version of the standard is applicable.

- Activities built before 2008 need not conform with any version of **EN 15567**
- Activities built between 2008 – 2015 should conform with both parts of **EN 15567:2008**
- Activities built from 2015 onwards should conform with both parts of **EN 15567:2015**
- Activities built from March 2020 onwards should conform with **EN 15567-1:2015 +A1:2020 and EN 15567-2:2015**

However, it would be deemed good practice for operators/owners, where practicable, to bring an existing ropes course and off-ground adventure activities course in line with EN 15567. Where this is not practicable, or historical evidence of compliance for the whole structure or some of its individual components is unavailable, it is incumbent upon the owner/operator to ensure that the activities are safe, which may require seeking competent advice. In the event of an accident or serious incident, the onus will be on the operator to demonstrate that they have carried out their due diligence and done everything that is practicable to ensure that the activities are safe to use. Bringing the course in line with EN 15567 as it is reviewed and republished will support you in achieving and evidencing this.

Examples of this may be upgrading a zip line braking system, updating of individual safety systems or improving the course for working at height.

If operators with existing courses decide to make new additions to their facility, then these

additions should conform to EN 15567. Like-for-like works do not require an inaugural inspection (e.g., the replacement of belay cables, ropes or the replacement of a rotten platform); however, substantive changes do.

Modifications to a course (that has already had an inaugural inspection in accordance with EN 15567) will require an additional independent inspection. This inspection can be carried out by a Type A, B or C Inspection Body.

### 6.5 Documentary obligations on constructors

In order to comply with EN 15567 the constructor or the installer of a new activity structure must provide a product manual containing at least the following information:

- A technical description of the facility and its individual components (material certificates etc.).
- Instructions relating to the correct use of the course are included in Annex B of EN 15567. This should include the specification for all associated PPE and safety equipment.
- A certificate of conformity to EN 15567.
- A manufacturer's declaration, containing at least:
  - » design calculations
  - » normative references
  - » exclusions of liability, if any
  - » instructions for maintenance specifying the frequency and method by which equipment is inspected and maintained

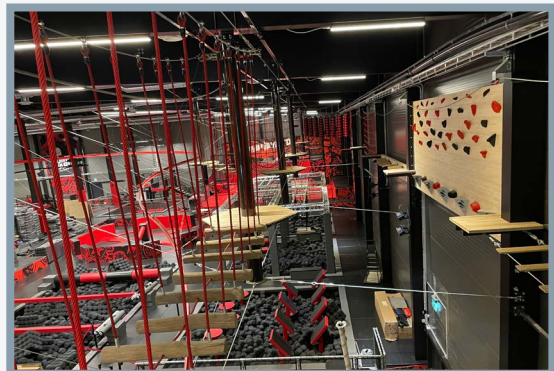





## 6.6 Documentary obligations on operators

In addition to the documentation that is required under UK Law and Regulations, EN 15567:2015 Part 2 requires an operator to ensure the following documentation is maintained. This will include:

- Name and address of the owner and operator.
- Document indicating the periodic inspections carried out by an inspection body.
- List of the site personnel, their function and qualification/competence.
- Evidence of public and employer's liability insurance.
- Daily inspection records. The daily sheets should be kept for three years.
- Accident and incident reports.
- Personal protective equipment inspection register and operation log.
- Risk assessment and management plan which shall be drawn up by the off-ground adventure activities operator.

- Instructor and rescue training documents which demonstrate instructor competence in their role.
- Participant safety instructions.
- Manufacturer's product manual.
- Safety and emergency plan.
- Current tree assessment report (if relevant).
- Safety instructions.

## 6.7 Obligations on participants

The age and experience of participants will have a bearing on their obligations. Operators must consider to what extent participants are able to fulfil their obligations. Adequate provision must be made for participants unable to fulfil their obligations.

Participants must be able to do the following:

- Comply with safety instructions and briefings.
- Bring any safety concerns to the attention of staff.
- Be careful of their own safety and the safety of others.

## 7. Inspections & maintenance

A comprehensive inspection regime is an essential part of ensuring that any ropes course and off-ground adventure activities course is fit for purpose.

With older ropes courses and off-ground adventure activities courses reaching the end of their serviceable life, and many new courses receiving vast numbers of recreational users, a professional approach to the inspection process is essential. Even with ropes courses and off-ground adventure activity courses at smaller venues catering for comparatively small numbers of participants, inspection and maintenance needs to be systematic and on-going.

To help with all levels of inspection and in order to comply with EN 15567, the constructor of the off-ground adventure activity must provide instructions for maintenance and inspections (including frequency), as well as a comprehensive set of drawings and design calculations.

In EN 15567 it is required that periodical and inaugural inspections are carried out by an inspection body that meets the requirements of: *'BS EN ISO/IEC 17020:2012 Conformity assessment. Requirements for the operation of various types of bodies performing inspection'*.

UKAS is the National Accreditation Body for the United Kingdom. They are appointed by government to assess and accredit organisations that provide services including certification, testing, inspection and calibration. At the time of the publication of this guidance, there is no option for an inspection body to be accredited by UKAS for inspecting to EN 15567.

As a result of the above, the two most common routes for inspection bodies to be audited, verified and their qualifications checked are through ADIPS and ERCA. Following a successful auditing process, both organisations will designate the appropriate status to the inspection body to carry out either inaugural inspections, periodical inspections or both depending on qualifications.

An ADIPS inspection body can carry out inspections to meet EN 15567. ADIPS independently verifies the competence of its registered inspectors so that owners of off-ground adventure activities can comply with the legislation set out in PUWER 1998, Section 6. ADIPS will audit against BS EN ISO/IEC 17020:2012, HSG 175, EN 15567 and any other relevant standards or guidance. For more information on ADIPS please go to <https://adips.co.uk/> 

Another route is to have an inspection by an ERCA-certified Inspection Body. ERCA will audit against a set of ERCA-own quality criteria, EN 15567 and any other relevant standards or guidance. In addition, it provides the inspectors with compulsory training and ongoing professional

development, specific to off-ground adventure activities, adventure parks and zip lines.

For a full list of ERCA-certified Inspection Bodies and how the scheme is structured and managed visit <https://www.erca.uk/index.php/en/training-and-inspection/about-certification> 

Should you wish to engage the services of an ERCA-certified Inspection Body be sure they are fully and officially audited by ERCA and not simply a member of the association. ERCA has a specific logo for its ERCA-certified Inspection Bodies, and this is what you need to look for on their websites and in their documentation.

Some companies offer and perform inspections in the UK that are not part of either of the 2 schemes mentioned above. It is incumbent on the operator to be satisfied that the inspection body's competency and suitability is sufficient and independent enough to meet the needs of the operator. It would be prudent to check what qualifications they hold to be able to inspect the components of your facility. For instance, and only as examples, are they competent in inspecting wooden poles, wire ropes, PPE or your specific safety devices, and do they hold appropriate training and qualifications for working at height?

Whichever route or option you decide upon for choosing an inspection company, the most important factor to consider is whether they are qualified and competent to carry out the inspection. Further, you must ensure they act safely when at your facility.





## 7.1 Inaugural inspections

EN 15567 requires that when a new ropes course or off-ground adventure activities course is built, but before it is used, an inaugural inspection must take place. This should be done by a completely independent Inspection Body. By definition, such an inspection body will have no commercial interest in the construction or maintenance of the ropes course or off-ground adventure activities course, nor any fiduciary interest in the facility to be inspected or other conflict of interest. They must also have their own public liability insurance for such work. Crucially however they must be competent and operators should take all reasonable care to ensure the competency and currency of the inspector and inspection body. EN 15567 recommends that a Type A Inspection Body (as defined by BS EN ISO/IEC 17020:2012) carries this out.

The inaugural inspection involves carrying out and documenting:

- Visual inspection.
- A review to ensure that the design calculation and / or tree strength assessment exists.
- A review of the current arboreal assessment to ensure that all trees used as a support system have been judged safe to use.
- Verification that the course has been constructed in accordance with the design drawings (e.g., guy angles). This is also referred to as an Assessment of Conformity to Design.
- A functional test carried out at height by an inspector. This means the inspector must have a comprehensive knowledge of courses and how they are used. The inspector should also be qualified and competent to work at height.

## 7.2 Periodical inspections

Periodical inspections should be carried out by a type A, B or C Inspection Body at least each calendar year and with a maximum interval of 15 months. The purpose is to establish the overall level of safety of equipment, foundations and surfaces. Operators should be aware that, whichever body you choose to employ to carry out your periodical inspections, Annex A from BS EN ISO/

IEC 17020:2012 details the level of independence required for all types of inspection bodies (A, B or C). It is beyond the scope of this guidance to fully explain these requirements however, no matter the type of inspection body, all three are required to act with a degree of independence between those who conduct the inspection and other parts of their business. The inspection body may also have a maintenance and construction capability.

The periodic inspection is a good opportunity for the operator(s) to be in attendance to answer and ask any questions and improve their knowledge. Examples of what the process should include are:

- visual inspection
- functional inspection
- assessment of the replacement state of worn components.



**Initial visual inspection would suggest no problems with this pole**



**Scrap away the gravel and fungal growth on the pole can be seen and should be done according to the manufacturer's or supplier's instructions for maintenance.**

For a full list of requirements refer to 7.1.4 in EN 15567-1:2015 A1+ 2020



A comprehensive report should be provided as part of this inspection and as a minimum this should include:

- Date and place of the inspection.
- Who carried it out.
- A summary of what was inspected.
- Results of the inspection indicating any defects observed.
- Recommendations for any remedial actions.
- Any misgivings about further use of any parts of the facility.
- A recommendation on re-inspection.
- A copy of the inspection report, which should be kept with the technical documentation of the off-ground adventure activity.

### 7.3 Operational inspection

This will be carried by the operator every 1-3 months or as directed by the constructor. Generally speaking, the constructor's recommendations should be considered a minimum; operators may consider more frequent inspections are required – based on their experience and on empirical evidence.

Examples of elements to be considered as part of visual and operational inspections are cleanliness, condition of ground surface, sharp edges, missing components, excessive wear (of moving parts) and the structural integrity of the safety system (e.g., condition of cables).



An operational inspection should be as comprehensive and thorough as a periodic inspection – the only difference being the latter has a greater degree of independence. This requires inspectors to be as competent and knowledgeable as they should be for a periodic inspection. For example, they may need to determine the degree of rot in a timber pole and decide, based on industry standards, whether it is acceptable. A thorough knowledge of wire rope discard criteria is invariably essential for an operational inspection. For some items of equipment, such as individual safety systems, the inspectors may need to attend specific training from the manufacturer of the device. (e.g., CLiC-iT® and ISC Wales ALF device).

There are now companies in the UK offering certified training courses in how to complete operational inspections, and there are also specific courses available in the UK for the inspection of utility poles and wire rope.

### 7.4 Routine visual check

This is done and documented before opening the course each day the facility is to be used. This check involves a visual survey of critical components and an assessment of the general appearance of the course and the surrounding environment. Elements to consider can be reasonably put into 4 groups:

- weather damage (strong winds, lightning etc.)
- vandalism
- animal damage
- wear and tear

The routine visual check is often done by an appropriately trained instructor. These daily inspections must also include any PPE and safety equipment used for the activity. This inspection must be in line with:

- The maintenance manual provided by the constructor.
- Instructions for any PPE and safety devices.
- The operator's risk assessment.

## 7.5 Tree inspections

In addition to what is written below please refer to clause 4.3.3.3.1 and Annex A in EN 15567-1:2015+A1:2020.



If trees are part of or within the vicinity of off-ground adventure activities they should be inspected prior to construction by a current and competent arborist who can undertake the appropriate tree inspections. Thereafter the trees should be inspected at least each calendar year and with a maximum interval of 15 months. The species, health, location and age of the trees will determine the frequency of inspections and the level of experience required of the inspector. If in doubt an expert arboriculturist (qualified to Level 3) should be consulted before the tree in question is used. However, arborists are not usually expected to be experts on off-ground adventure activity courses.

Trees may also need to be inspected after a severe storm or with the appearance of fungus or obvious deterioration in the health of the tree.

Tree inspection reports should be retained.

## 7.6 Maintenance

Inspections and maintenance are intrinsically linked. Minor maintenance is often best done by the operator during the routine visual and operational inspection. This may include replacement of maillon rapides, shackles and small ropes. More significant maintenance - for example the replacement of cables, poles and platforms - will usually be carried out by a professional ropes course and off-ground adventure activities construction company.

## 7.7 Work at Height Regulations 2005 (WAHR) and inspections

In 2007 the WAHR were amended to include persons instructing climbing and caving.

**Note:** The ERCA training awards and Standards alongside EN 15567 can be considered as equivalent "established good practice" as referenced in the WAHR.

During routine visual checks and possibly for some operational inspections, instructors / inspectors may use the same PPE and practices as participants would normally use, provided they are going around or over the facility in the same way that participants normally would. This assumes that established good practices are followed.

The requirements of the WAHR apply to any work at height (as defined in the WAHR, reg.2 below).

"work at height" means -

(a) work in any place, including a place at or below ground level;

(b) obtaining access to or egress from such place while at work, except by a staircase in a permanent workplace, where, if measures required by these Regulations were not taken, a person could fall a distance liable to cause personal injury.

During all other forms of inspections, maintenance and construction work, practices consistent with WAHR are required. This may include the use of industrial harnesses and other industrial PPE and may involve the use of dual rope techniques. It is beyond the scope of this guidance to provide the details of WAHR and maintenance techniques, but inspectors should be conversant with the WAHR before carrying out their work. Additional training is likely to be required for those wishing to fulfil such roles. There are a number of specialist companies that are able to provide such training.

It is worth noting that under Regulation 6 of the WAHR, there is a hierarchy of control for determining how to work at height safely. The hierarchy has to be followed systematically, and only when one level is not reasonably practicable may the next level be considered. It is not



acceptable to select work equipment from lower down the hierarchy (e.g., personal fall arrest, such as harnesses and lanyards) in the first instance. Wherever possible the need to work at height should be minimised. This may be achieved with a carefully designed off-ground adventure activities course. The method of working at height should be decided upon by undertaking a risk assessment and taking into account the work required and its duration. Where appropriate, collective safety systems should take priority over individual safety systems and the use of a Mobile Elevating Work Platform (MEWP – colloquially known as a “Cherry Picker”), where reasonably practicable, may be the most appropriate option to take.

Vertical access, in particular, requires careful consideration. Please remember that for the purposes of maintenance, attaching yourself to staples as a means of fall arrest is inappropriate because they are (normally) untested, unapproved and unquantifiable in terms of their security and dependability as anchors. Generally, an industrial device designed for use on vertical cables or rope is required. Alternatively, inspectors can be belayed (up and down) using a single rope running through a rated top anchor by an assistant. One option to gain access to perform an inspection is to install an industrial fall arrest device for ascending or descending the activity structure. These normally consist of cable, rope or rails and a traveller that locks automatically should a fall occur.

It should be noted that the WAHR require the operator to ensure that the planning for any work at height must include planning for emergencies and rescue. These plans must take into consideration participants, instructors and persons completing construction, maintenance and inspections. It is the operator’s duty to ensure that contractors on site, completing any of those roles, must have sufficient plans and means in place for emergencies and rescue. This could include them asking the operator to provide a suitably qualified and competent rescuer whilst they carry out their inspection or maintenance on the facility.

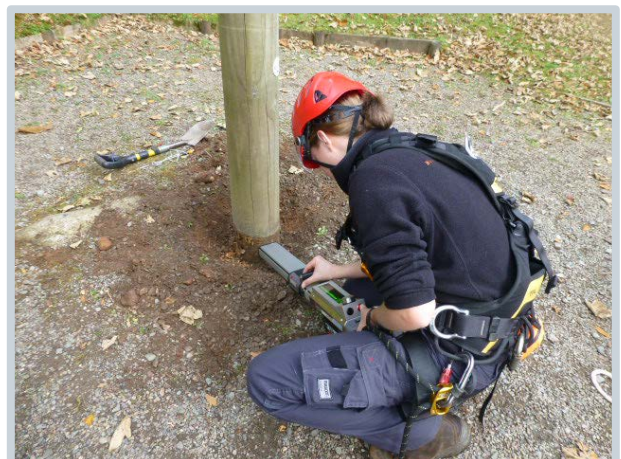

**Inspector carrying out inspection**



## 8. Operation

This section relates to EN 15567:2015 Part 2 Operations.

**New and Existing Courses** – Part 2 of the EN is relevant to all operations on both new and existing off-ground adventure activities courses. All ropes courses and off-ground adventure activities operators are encouraged to refer to the EN.

### 8.1 Good practice

Identification of associated risks and the development of operating procedures is required by both the MHSWR and EN 15567.

An assessment of the hazards and risks, specific to your operation and also to each different type of activity should be done. When carrying out this assessment you may identify individual sections or elements of the activity that have their own specific risks that need to be controlled. These risk assessments inform the information, instructions and training provided to employees. They are also used to develop appropriate operating procedures that balance the excitement or other benefits of the activity with their safe use.

Participants have certain obligations. However, these will vary depending on their age and experience. You may want to consider participant attitude and behaviour when determining how much self-responsibility will be appropriate.

Participants should be briefed to be careful about their own safety at all times and that of others. They should be told to comply with all safety instructions and be reminded when necessary. Providing this information at the time of booking (website and reception areas) as well as on signs at appropriate locations at each activity will strengthen and reinforce the briefings provided by instructors.

For some types of operation or activities such as a developmental or educational programmes, providers may choose to encourage participants to be as fully involved in the measures to ensure their own safety as the provider feels is reasonable. Where possible participants - even young participants - can be encouraged to carry out as many of the relevant safety procedures as they can, with the instructor providing a double, visual and, where practicable, physical check. This may well influence what those procedures are and what equipment is identified as the most appropriate.

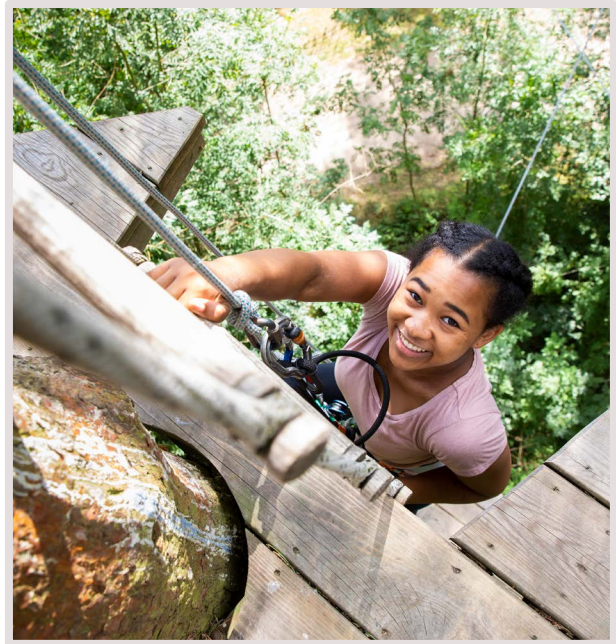

In some cases, this may reduce the risk of a human error accident and will likely increase the learning potential.

No person should take part in any off-ground adventure activity whilst under the influence of alcohol or drugs. Participants should be reminded that certain prescription drugs also inhibit safe participation in off-ground adventure activities.

### 8.2 Identification of appropriate instructor competence

This is likely to be the biggest single factor influencing the safety of these activities. There must be a system of identifying and verifying the required competence of instructors and their assistants. Technical competence, including measures designed to minimise human error and the consequences thereof, are essential, but so too are measures in how to supervise participants, how to intervene to prevent an incident or unsafe action, how to coach and encourage participants, and where appropriate, how to observe and be ready to conduct a review.



### 8.3 Instructor induction

An induction process is likely to be required. This would include, but is not limited to:

- company health and safety policy
- roles and responsibilities
- general site safety policies such as
  - » fire procedures
  - » emergency action plans
- reporting of accidents, incidents and near misses
- how the equipment is stored, including quarantining procedures
- course paperwork and documentation
- participant booking processes
- participant limitations to participation

It must be clear who is to conduct this induction, what it covers, what form it takes, etc. Details of the induction should be retained.

### 8.4 Instructor training

Operators should ensure that instructors are equipped with the skills necessary to deal with any reasonably foreseeable and relevant occurrences on each activity and element used. This will often require training on the elements themselves and should include at least some practical incident and accident scenarios and responses. Detailed knowledge of each element is likely to be one of the major factors in the safe delivery of these activities. Details of the training should be retained.



Instructors should generally wear the same or similar equipment as participants during their training and when giving demonstrations. Rescue techniques should be practiced regularly, with first aid and other scenarios included to ensure familiarity.

Any qualification system for off-ground adventure activities should address the following aspects of training:

- Those overseeing training are competent to do so.
- Full records are kept of training courses, including the syllabus/training programme followed.
- Full records are kept of instructors' on-going experience.
- There is a detailed assessment of training practices and instructor's competence.
- There is on-going monitoring and development of instructor competence in their role.

For those who wish to follow a recognised training scheme, ERCA has a process for ERCA-certified Training Bodies, similar to that of its Inspection Body Scheme. ERCA-certified Training Bodies are audited regularly and only employ trainers who are qualified to the scheme and follow the ERCA training syllabus when delivering a course.



ERCA trainers meet regularly for CPD days and to share good practice.

Just like the inspection scheme, there is a specific logo for ERCA-certified Training Bodies that enables you to distinguish them from those companies who are simply ERCA members.

For a list of ERCA-certified Training Bodies and details of the scheme follow this link

<https://www.erca.uk/index.php/en/training-and-inspection> 

### 8.5 Identification of group competence

Increasingly, ropes courses and off-ground adventure activities are offered as 'one-off' experiences to a wide range of groups, from primary schools to corporate groups as well as





members of the general public, frequently in a recreational/pay-to-play capacity. When possible, a policy of identifying the competence, experience, special needs and physical and medical condition of the participants in advance of their participation is advisable. However, for pay-to-play operators this may simply be impracticable. When you can, and as a result of differing levels of participant competency, it would be equally acceptable to either:

- Select the elements on the basis of the client group; or
- Select the client group on the basis of the elements available.

With no previous knowledge of a participant's experience and competence, operators should assume that neither exists. This is particularly important in relation to children.

## 8.6 Acknowledgement of risk

A policy of informing the participants of the nature and extent of risks and what to expect from the activity is encouraged. This is particularly important where the participants may have no concept or prior knowledge of this type of activity.

It may be unreasonable to expect an operator to detail the hazards in their primary advertising. However, it may be reasonable, for example, to leave this information until the point of booking or even (in some cases) until arrival and within the activity briefing. The identification of risks should be clear, and allow realistic and uninhibited options to any participants who, as a result, may wish to decline the activity.

## 8.7 Identification of element options

It may be beneficial to have alternative elements or alternative start or finish points. In some cases, the degree of difficulty or the duration of the exercise or both can be determined by varying these. On the day and through a risk assessment, the most appropriate elements should be used depending on factors such as the weather conditions, nature, experience and expectations of the group, the number and experience of staff available, etc.

## 8.8 Human error accidents

Serious accidents on ropes courses and off-ground adventure activities are still rare. Where accidents have occurred, human error is a leading contributing factor. Human error accidents are caused by a wide range of factors including incompetence, task overload and fatigue but most importantly distraction of one sort or another. Distraction may be more difficult to identify than mechanical failure and therefore more difficult to prevent.



When we refer to human error or human factors in this guidance, we are referring to *'environmental, organisational and job factors, and human and individual characteristics, which influence behaviour at work in a way which can affect health and safety'* **Reducing Error & Influencing Behaviour (HSG48, 1999)** 

This guidance covers three interrelated areas: the job, the person and the organisation. Or, quite simply put:

- What are people being asked to do (the task and its characteristics)?
- Who is doing it (the individual and their competence)?
- Where are they working (the organisation and its attributes)?

See table on page 36.

You can find examples of accidents and incidents, including human error, that have occurred during ropes courses and off-ground adventure activities by clicking on the following two links:

- [www.outdoor-learning.org/AALA](http://www.outdoor-learning.org/AALA) 
- [www.erca.uk/index.php/en/publications/safety](http://www.erca.uk/index.php/en/publications/safety) 
- <https://adventurerms.org.uk/updates/> 

Following accidents, there have been successful prosecutions of ropes course and OGAA operators in recent years. You can find details on these by searching the following databases

<https://www.shponline.co.uk/prosecution-and-in-court/> 

<https://www.hse.gov.uk/enforce/convictions.htm> 

<https://www.ioshmagazine.com/categories/article-types/news> 



Below, you will find some suggestions as to how you can reduce human error at your site and for your activities.

**Ensure instructor competence.** Competence should be gained by appropriate training and experience as specified by the operator's risk assessment and health and safety policy. An appropriate qualification and training record (or similar) should be kept as evidence.

**Deploy staff carefully.** It is almost inevitable that any instructor doing any highly repetitive task will eventually lose concentration, their mind will wander, and they will make a mistake. If the task is safety-related, then the consequences can be catastrophic. Similarly, deploying the same instructor to the same element day after day is likely to result in the same 'task fade'.

**Avoid long periods of the same repetitive task.** Staff should be deployed so as to minimise excessive exposure to repetitive tasks. One solution is to make sure employees have plenty of breaks. However, an alternative approach is to ensure the instructor moves on to a different task at frequent intervals. A different repetitive task is better than keeping to the same one.



**Avoid element-specific instructors.** Training instructors so that they can run different elements is likely to make the experience more rewarding as well as safer for the participants and the instructor. Operating a 'group instructor' system means one instructor stays with the same group of participants through their experience. An instructor will learn what participants are like, who needs extra encouragement or extra attention, which participants they can trust and who needs particularly close supervision.

Job Factors	Person Factors	Organisation Factors
System/equipment interface	Physical capability & condition	Work pressures
Routine or unusual tasks	Fatigue (acute or chronic)	Supervision/Leadership
Divided attention	Stress/morale	Communication
Procedures inadequate or inappropriate	Work overload/underload	Manning Levels
Working environment (noise, heat, space, light and ventilation)	Competence	Clarity of roles and responsibilities
Time available/required	Motivation	Consequences of not following procedures
Tools appropriate for task		Organisational or safety culture
Communication		



**Use 'mental' checklists.** Preparing a participant for some activities can be a multi-step process. Part of an instructor training scheme could be to encourage instructors to run through a 'mental' checklist.

This could be a sequential check of the safety 'chain', or following some convenient mnemonic.

A good example is **C.H.E.C.K.**, which can be used before an instructor allows the participant to step off the platform or leave the ground:

- C Clothing.** (to include hair, pockets, jewellery and footwear).
- H Harness/Helmet.** Are they correctly fitted?
- E Environment.** Is the zip landing clear, are there any spectators about to enter the area, is the weather about to change?
- C Connections.** Are they safely connected to the safety system?
- K Knowledge.** Do they have the correct knowledge to safely take part in the activity?

The key thing is to avoid saying "GO" merely because the last step in the sequence has been completed without first checking that all the steps have been completed.

**Use participant involvement.** The participant is the person present with the greatest vested interest in their own safety. It makes sense, therefore, to include them in the process of ensuring their own safety. The participant 'does' and the instructor 'checks' is particularly relevant to supervision levels 1 and 2. Two brains and two sets of eyes are invariably better than one: the so-called duality principle.

**Be participant centered.** The duality principle (above) may require operators to revise their procedures, the equipment they use and the way they use it so that the participant can understand and play their part in the process. Involving them in the process makes the activity more satisfying for the participant, but it also makes it safer. If you are including the participant in their own safety it is advisable to design either procedures or specific ground training and practice areas where they can practice and instructors can assess their ability before they start the activity. For categories

A-C individual safety systems, these training and test areas are a requirement of EN 15567. If this is not possible, then a double check by another instructor may also enhance safety.

**Avoid task overload and concentration loss.**

The biggest single cause of human error accidents seems to be that the instructor was distracted. This might be because they were distracted by some other relevant task or by too many concurrent tasks, and the risk of this is increased by making the instructor responsible for multiple tasks. However there have been accidents, some serious, that occurred because the instructor was simply focused on some totally unrelated issue: they were day-dreaming. Practices and procedures need to be considered in terms of keeping instructors focused.

**Monitor all staff from time to time.** An effective measure to prevent a wide range of human error accidents is for management to monitor staff routinely in their normal working environment.

**Respond to poor practice.** Individual cases of poor practice that are observed can be dealt with immediately. More widespread cases of the same poor practice would lead to adjustments to initial training or refresher training procedures.

**Nurture your staff.** The fact that instructors see management taking a real interest in safety reinforces to them that their management appreciates that what they do on a daily basis is important. Conversely, if instructors feel that management do not care, then gradually instructors will not care either. If instructors don't care, then they will make mistakes, and if they make mistakes, sooner or later these will result in accidents.

It is important that adequate consideration is given to equipment and procedures that minimise the likelihood of a human error failure. Avoiding human error is really about ensuring that:

- » These people;
- » with this training;
- » and this equipment;
- » can do these tasks;
- » safely, effectively, satisfyingly; and
- » under these conditions.



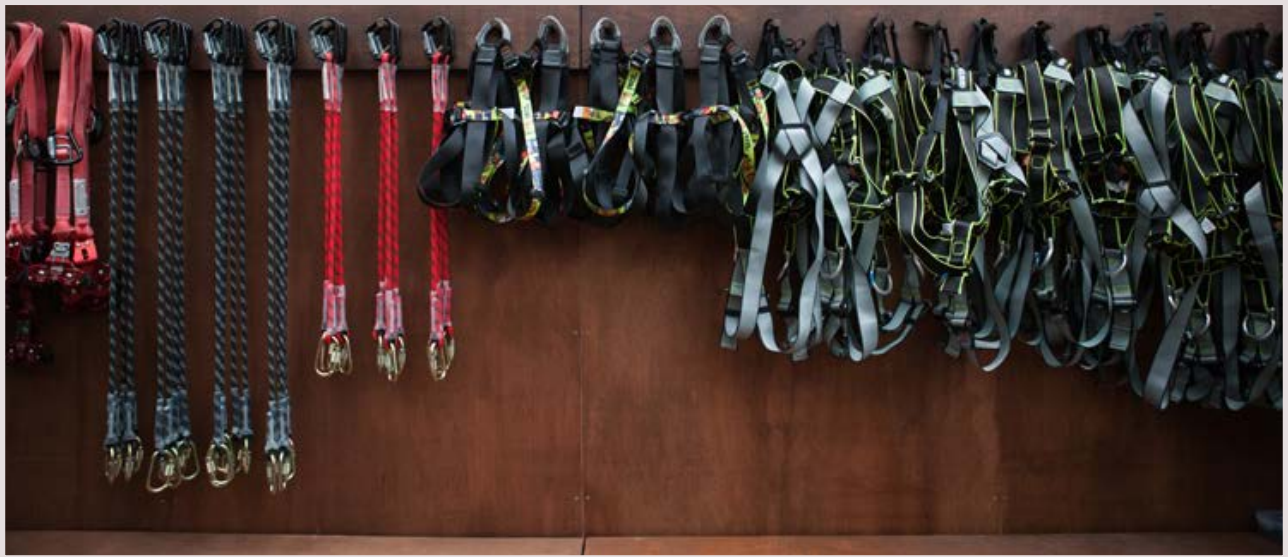

## 8.9 Equipment

This includes both personal and group equipment. Equipment selection will depend on the nature of the elements, the abilities of the group, the weather and other factors. However, certain aspects may become company policy, such as whether to use sit harnesses or full body harnesses on high ropes elements or helmets on low challenge course elements.

In EN 15567 it is a requirement that the constructor of the activity provide, within the owner's manual, a list of the equipment required to operate the activity. It may also be advisable to seek competent advice, as the choice of equipment is vast and getting it wrong can prove to be a very expensive mistake and may also lead to accidents or other unintended problems. Here is a list of things to consider, but it is by no means exhaustive:

- The choice between the types of harness should be carefully considered. In recent years there has been a move towards the use of full body harness on off-ground adventure activities; however, it is too simplistic to suggest a full body harness is always preferable. The most important consideration is that a harness fits well and is secure.
- In some activities, there may be an unacceptably high risk of head injury, which could be adequately reduced by wearing a helmet. The most appropriate helmet may not be a climbing helmet. In other instances, the risk of head injury may be low and outweighed by the need for clear communications, visual recognition of participants, etc. and so helmets may not be appropriate. In either event, the operating procedures should make it clear if there is an inflexible policy. Similar decisions will be necessary about the need for particular footwear, outer clothing, and so on.
- Other pieces of clothing or equipment such as gloves may be considered useful but not essential.
- Group equipment may also be affected by the venue's proximity to other resources such as centre buildings, first aid room, etc.
- When advising participants or group leaders, it may be appropriate to list both group and personal equipment under headings such as 'must have' and 'may have'.
- Because equipment requirements may vary from day to day and group to group, it will need to be clear who decides what clothing and equipment is necessary for a particular session or a particular day. It will also need to be clear who checks this, when and where they do it, and what they need to do if it is not correct or acceptable.
- Operations must also make provision for respecting and understanding cultural and religious beliefs and distinctions when it comes to the selection of equipment, requirement for clothing and operational procedures.



PPE and safety equipment should be checked in accordance with manufacturer's recommendations, and a record of this should be kept in line with the following legislation, where relevant:

- LOLER - <https://www.hse.gov.uk/pubns/books/l113.htm> ↗
- PUWER - <https://www.hse.gov.uk/pubns/priced/l22.pdf> ↗
- PPE at Work Regulations - <https://www.hse.gov.uk/pubns/priced/l25.pdf> ↗
- WAHR - <https://www.hse.gov.uk/pubns/indg401.pdf> ↗

Consideration should be given to dealing with participants' personal clothing. A list of what to wear will be helpful. You may wish to consider a plan (or supply of spare clothing/overalls, etc.) to accommodate participants who arrive improperly dressed for the activity.

Equipment should be used in accordance with the manufacturer's instructions. Where there might be a requirement to deviate from these, confirmation of acceptance of this should be gained from the manufacturer or their distributor.

## 8.10 Weather forecast

A policy for obtaining and interpreting weather forecasts may be needed. It must be clear who is to do this, when it is to be done, and what action they will take for a range of possible forecasts. These could include, but may not be limited to:

- modification or selection of the elements
- modification of clothing, footwear or equipment
- change of venue
- cancellation and / or return of payment

If the addition of another instructor is the response, then there must be a system whereby suitable persons can be deployed in the given time span. Lightning strikes pose a real threat to off-ground adventure activity users. The following website provides a 'real-time' link to lightning strikes in the UK.

<http://www.netweather.tv/index.cgi?action=lightning;sess=> ↗

ROSPA also provides some interesting information on lightning strikes:

<http://www.rospa.com/leisuresafety/adviceandinformation/leisuresafety/lightning.aspx> ↗

## 8.11 Number of participants per element

It may be acceptable to specify this generally (i.e. for the whole course) or specifically (for each element or activity). Constructors have an obligation to provide this information under the requirements of EN 15567-1:2015+A1:2020 (Annex B).

## 8.12 Participant's morphology

Participant's size and weight may also be a factor in determining whether or not they can participate in an activity. This is often critical on large zip lines, giant swings and free-fall drops, and as a result it is often recommended to weigh people or measure their height in some way before they are allowed to take part.

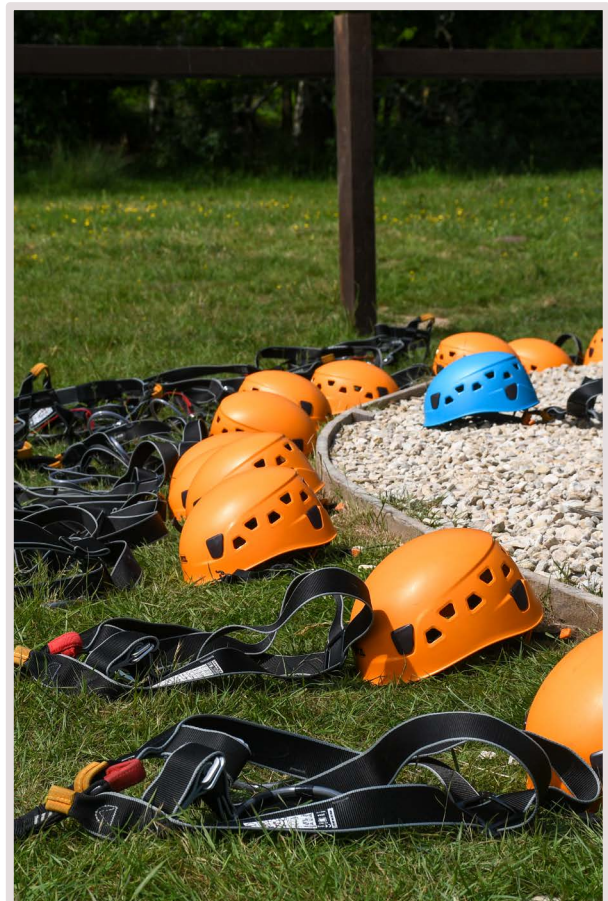

## 8.13 Briefings

There will need to be a policy on the existence, content and presentation of safety briefings. This may be part of an overall safety briefing for the off-ground adventure activity's session in its entirety, or for each element.

For all activities there will be some information the participants need to know, understand and remember in order to take part safely. This can range, depending on the activity, from two or three simple instructions such as "hold here", "keep your head to one side", or "stay on your climbing line", all the way up to a very large set of safety rules and instructions, such as how to look after others, how to get help when needed, how to navigate activities or elements and how to manipulate and operate the safety system.

When designing your safety brief(s) you will need to ensure you have taken into account the instructions for the activity from the constructor and also specific instructions from the manufacturers of individual safety systems and other safety devices. In addition to this, the level of training and the information provided to participants via a brief shall be determined by the operator's risk assessment. EN 15567-2:2015, 6.1 and 6.2 lists the requirements for safety instructions.

Here is a summary, but remember you may need to include more than this based on manufacturer's instructions and your own risk assessments:

- An explanation of the ropes course and off-ground adventure activities and risks of serious injury which have been identified in the operator's risk assessment. These might not be limited to the safety system.
- Explanation of the safety instructions.
- Identification of instructors and how and when to communicate with them i.e., in the event of an accident or where a participant requires assistance.
- An explanation that at any time any participant shall be within range of sight of either an instructor or an adult participant.
- Explanation and demonstration of the correct use of the equipment.
- Explanation of any marking or signage placed at the start of an activity or an individual element.
- Information about practical assessment, if being used.
- Explanation of the responsibilities of a supervising adult.





You may also wish to consider when and how this information is delivered to the participants. For simple briefings for activities where the majority of their safety is controlled by the instructors, a simple verbal briefing just before they take part may be sufficient.

For more complex activities where the participants take more responsibility for their own safety and that of others, you should consider delivering the information to them in multiple formats and multiple times. They need to have heard, understood and remembered the information. They also need to be able to perform any required skills or methods you are expecting of them whilst they take part. You should consider the content and the delivery of the safety brief(s) as important and as critical as your PPE, course checks and all other aspects of your safety plans. Here are some options for delivering this information:

- On your website at the point of booking.
- On signs and briefing points at appropriate locations at your venue.
- Briefing videos.
- Verbally by instructors before the various stages of getting participants ready.
- On activity or element-specific signs at specific locations on the course.



## 8.14 Use of adult supervisors

For some activities, EN 15567 requires that an adult supervises a child at height. It must be pointed out that it does not require the adult to always be up, on the activity with them. It can be okay, based on a risk assessment, for the adult to supervise from the ground.

What is clear is that arbitrary enforcement of adult supervision on the activity (mandating that the adult physically take part) can actually lead to more problems than it solves. Careful consideration needs to be given as to why you are asking an adult to take part, who that adult is, whether they have been trained to take responsibility for the child in their care and whether their ability has been assessed.

Study this table from the standard carefully. Only where there is a (b) is adult supervision required.

### Individual safety systems

Minimum supervision levels 1 to 3 depending on safety categories and the participant's age

		Test Course				First five change-overs <sup>a</sup> after the test course				Rest of the course			
		< 6	6 to 9	10 to 13	from 14	< 6	6 to 9	10 to 13	from 14	< 6	6 to 9	10 to 13	from 14
Category of the individual safety system	A	1	2	2	2	1	2 <sup>b</sup>	2 <sup>b</sup>	2	1	2 <sup>b</sup>	3 <sup>b</sup>	3
	B	1	2	2	2	1	2 <sup>b</sup>	2 <sup>b</sup>	2	1	2 <sup>b</sup>	3 <sup>b</sup>	3
	C	1	2	2	2	1	2	2	2	2 <sup>b</sup>	3 <sup>b</sup>	3	3
	D	1 <sup>c</sup>	2 <sup>c</sup>	2 <sup>c</sup>	2 <sup>c</sup>	2 <sup>b</sup>	2	3	3	3 <sup>b</sup>	3	3	3
	E	1 <sup>c</sup>	2 <sup>c</sup>	2 <sup>c</sup>	2 <sup>c</sup>	-	-	-	-	3 <sup>b</sup>	3	3	3

- a For courses using a category D safety system, the first five change-overs may be included within the test course. In this case the supervision levels of the test course apply.
- b Accompanied by a supervising adult.
- c If required under 6.3.3.



EN 15567 also requires the following for adult supervisors:

- Training for supervising adults shall include the safety instructions.
- Correct attachment of the safety system with particular reference to change-overs undertaken by the child(ren) in their care.
- Advice on the appropriate method with which to observe the child(ren) in their care.
- Where there is a conflict in advice, it shall be made clear that the instructions of the instructor take precedence.
- The training shall be assessed e.g., by questions.

It also states that the decision regarding whether the supervising adult accompanies the child(ren) in their care from the ground or at height shall be made by the operator based on their risk assessment. The method of observation which the supervising adult shall use while accompanying the child(ren) in their care shall also be based on the risk assessment.

## 8.15 Assessment of participants' understanding of the rules and ability to operate their safety system

EN 15567 has specific requirements for the assessment of participants and adult supervisors before they can take part.

These assessments can be done quickly via a few questions or through a quick demonstration of understanding from the participant. This may be all that is required for spotting on a low ropes course or before climbing up a belayed activity such as a leap of faith.

For more complicated systems, or for activities under level 2 or 3 supervision and for adult supervisors, this assessment may be more in-depth including a clear demonstration on a practice or test course before they can take part. Remember, you want them to fully understand and to be able to perform these skills.

If you operate a zip line that requires them to actively brake, this must also be assessed before they can take part.

## 8.16 Technical advice

Under the HSWA, an owner and/or operator has a 'duty to protect the health, safety and welfare of your employees and other people who might be affected by your business.' ([HSE Website](#)) ↙

The HSE is clear that as an employer you must appoint a competent person or persons to help meet the health and safety duties to your employees and customers.

The HSE defines a competent person as someone who has:

*'sufficient training and experience or knowledge and other qualities that allow them to assist you properly. The level of competence required will depend on the complexity of the situation and the particular help that you need'* ([HSE Website](#) **"A Competent Person"**) ↙

An operator may well have appropriately qualified staff who meet the definition from the HSE and remain current and competent in the relevant activities. However, if the activity falls beyond the experience or competence of management, it will be necessary to get advice from one or more appropriately competent person or persons. It may be necessary to determine 'appropriate' from first principles by considering the requirements of a particular element or venue.

If an operator does not have this internal expertise, they can appoint an external technical adviser (competent person) to advise on the safety, industry and operational matters.



The principal role of a technical advisor is to help make relevant and informed management decisions. A good technical advisor can have significant benefits to an operation by offering support as well as improving operational decision-making. Before appointing an external technical advisor, consider the following:

- Ensure they have extensive practical and theoretical and technical knowledge of a wide variety of activities and/or specific elements.
- Ensure they have knowledge and experience of the relevant type of off-ground adventure activities and how they are run.
- Ensure they have sufficient freedom of action to evaluate the situation and provide advice freely.
- Ensure they are currently involved in the industry and keep themselves abreast of developments.
- Demonstrate they will be proactive in their role.
- Ensure they have proven history in appropriate client groups and course activities.

You may choose to appoint technical advisors who hold one or more of the following awards:

- An ERCA-certified Trainer
- Currently active Mountaineering and Climbing Instructor and/or Winter Mountaineering and Climbing Instructor or
- A person who holds a Caving Instructor Certificate (CIC)

**However, it is important to remember that none of these awards train, qualify or assess the holder to be a technical advisor and that the standard caving and mountaineering training courses do not specifically deal with ropes courses or off-ground adventure activities.**

However, if all you require is a person with greater knowledge to help with equipment decisions, technical questions about the activity or for



training/assessing staff, then they may well be an appropriate technical advisor.

If you want to appoint a technical advisor to help with your duties under Health and Safety law and secondary legislation, including the review of risk assessments or safe operating procedures, then you need to ensure that they are competent for this role in addition to their activity and technical qualifications.

To help you make this decision, a common acronym used to measure if a person is competent to assist with your Health and Safety duties is SKATE (Skill, Knowledge, Attitude, Training and Experience). You may want to consider what skills, knowledge, training and experience they have with regards to health and safety in addition to their activity and technical qualifications.

By whatever process you decide to ensure you have appropriate competent advice for your activity operation, if it involves an external technical advisor it is recommended and considered to be good practice to have a contract in place which clearly states their responsibilities and what is expected from them (and you) and when it is expected. This will provide transparency and will serve to reduce the likelihood of future conflicts.

## 8.17 Recognised certification schemes and auditing your operation

The HSE provides clear guidance on how a thorough and effective Health and Safety system should be structured for your operation through its guidance document **HSG 65 Managing for health and safety**. You can download a full copy [here](#) ↩.

HSG 65 uses the Plan, Do, Check, Act Model shown here. Whilst there are many ways you can meet the guidance and apply the full model, there are two well-known external services providing auditing options specific to our industry that can assist you with the requirement to CHECK and provide you with advice, reports and evidence that you meet their standards. You can, of course, provide your own auditing, but for many operators these services are a good option.

Off-ground adventure activities and ropes courses are currently outside the scope of the Adventure Activities Licensing Regulations and so providers/operators do not require a licence for these type of off-ground activities. However, the Licensing Authority and Service also consider the safety management of non-licensable activities, as a part of the providers culture of safety overall, in reaching the decision on whether to issue a licence. They will refer to this guidance when determining whether or not good practice is being followed.

### 8.17.1 Adventure Activities Licensing Authority (AALA)

Use of the AALA as a safety auditor is often not required or available to most OGAA providers. This is because the structures and activities do not come within the statutory requirements of holding an AALA Licence.



However, if you operate AALA licensable activities in addition to your OGAA with under 18s, then AALA are able to audit the safe operation of these out-of-scope OGAA as well.

For more information about AALA and the scheme, visit [www.hse.gov.uk/aala/index.htm](http://www.hse.gov.uk/aala/index.htm) ↩

### 8.17.2 Adventuremark

Adventuremark is a scheme created by AAIAAC to provide an equal level of oversight, auditing, advice and reporting to that of AALA but for activities and operators who do not come under the requirements to hold an AALA licence.



Although it is a non-statutory scheme, it is a scheme that is chosen by many operators with an OGAA to aid and assist them in ensuring safe provision.

For more information on Adventuremark and how to apply for it, visit [www.adventuremark.co.uk](http://www.adventuremark.co.uk) ↩

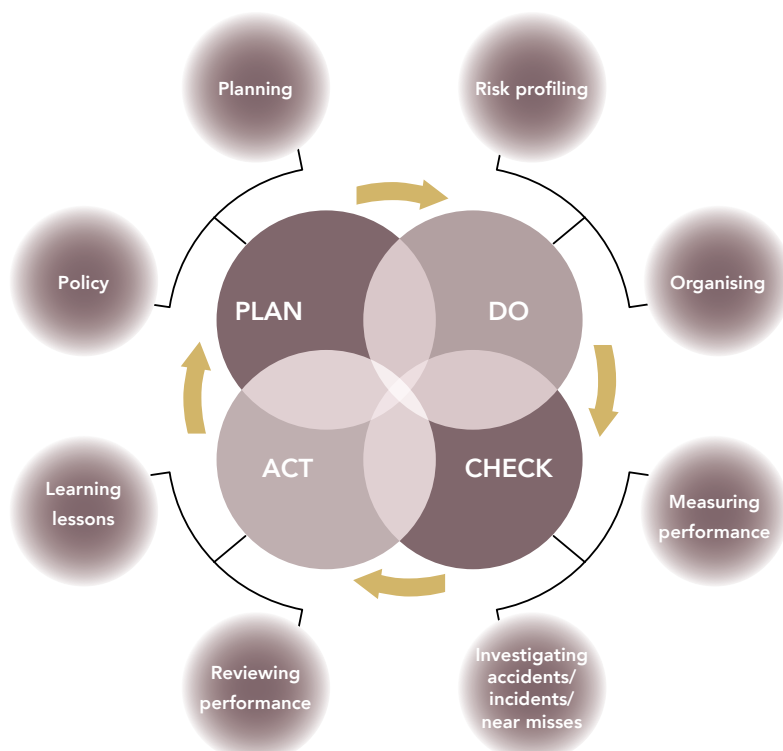



### 8.17.3 ERCA – European Ropes Course Association

Currently ERCA provides no service for a member to be audited for safe operation of OGAA.

ERCA does have 2 auditing schemes available for Inspections Bodies and Training Bodies. These can be identified by the 2 logos.

When an operator is looking to select an ERCA-certified Inspection or Training Body, they should look for these logos, as they demonstrate that the ERCA member and its services, safe systems of work and quality of service have been audited by ERCA. It is only these Bodies that can provide you with official ERCA certificates of Inspection or Training.



ERCA does have a plan to implement a scheme for operators to be audited for their safe provision of OGAA, and when this is available it will be announced to the industry.



### 8.17.4 Other ways to audit your operation

In addition to or as a replacement to the above schemes, you may wish to carry out or complete your own auditing of your OGAA as a way to ensure compliance with UK Health and Safety laws. You can either do this internally with your staff team or externally by using a consultant, or even both. Whichever you decide, it is critical you consider the following 3 points:

- Are the auditors free to act in this role without fear of reprimand or pressure to overly favour the owner/operator of the OGAA?
- Are they competent with proven experience in the field of safe operation of the type of OGAA you have?
- Are they competent and ideally qualified, and can they provide evidence of the training they have in regard to health and safety systems and law?

For more information and advice on internal and external Health and Safety audits please visit **ROSPA's website**  where there is some good advice on the topic.

## 8.18 Medical conditions and/or disabilities



There will generally be a need for checking any conditions which may require a participant to receive special attention, or who may need to be excluded from the activity. If this calls for additional personnel there will need to be an appropriate system for making them available.

## 8.19 Manual handling

Participants on some activity elements should be briefed about manual handling problems. The extent of this will be influenced by the age, fitness and prior experience of participants individually and collectively.

## 8.20 First aid

In addition to having normal first aid facilities, it is good practice to carry out scenario-based training, using actual elements, so instructors and operators can identify the problems as well as the solutions particular elements may present and additional specialist first aid equipment you may require.

For further information in regards to your first aid duties, please refer to the **The Health and Safety (First-Aid) Regulations 1981**  (amended 2013) and **L74 the ACOP** .

## 8.21 Emergency action plan

This could be integrated with the scenario-based training mentioned in First Aid above. It would be normal to include this as part of an induction procedure. Consideration should be given to the safety of all participants, not just those injured or immediately affected. Consideration should also be given to the evacuation of all personnel from the site (spectators etc.) and, in some large commercial operations, this could run to many hundreds. The need for regular (documented) practice, refresher training and full reviews of emergency action plans and rescue systems cannot be overstated.

Remember to include a plan to cover staff performing inspections and maintenance on your activities as well. This may well include rescue or recovery from locations beyond the safety system used by your participants.

## 8.22 Off-elements supervision

Participants not involved in an element may be harmed in a variety of ways. For example, participants 'waiting their turn' can wander off or try other elements unsupervised.

EN 15567 requires ropes courses and off-ground adventure activities to be adequately marked for spectators and participants.

You may also wish to consider including methods of easily identifying instructors (e.g., by wearing distinctive uniforms).

## 8.23 Fire risk

Due to the flammable nature of many sites, a no smoking policy may be appropriate.

## 8.24 Individual safety systems and the 'double unclipping' problem

No single measure seems to have totally prevented incidents of participants completely unclipping both lanyards from the safety system whilst traversing sections of a self-belay ropes course and off-ground adventure activity (Safety System Categories A and B).

A number of measures may, however, be effective in minimising the risk of injury as a result of a 'double unclip'. A double unclip, where the participant remains on the activity structure and does not fall off, is considered to be a near miss but is not a dangerous occurrence as defined by RIDDOR.

When operating individual safety systems in categories A to D, after participants have successfully completed the first 5 changeovers the level of supervision may then reduce to level 3 dependent upon the participants' age. Operators should be aware that if this is how they intend to operate their course then there are additional requirements under EN 15567 in terms of the marking of elements, special safety instructions, etc. Constructors may also design in options to take easier routes or provide the ability for participants to make their way safely off the activity should they find it too challenging.

Since the publication of the earlier editions of the UK Ropes Course Guide, different technology

has evolved that, when properly functioning and maintained, helps to reduce the possibility of 'double unclipping'. These are categories C and D which are - 'interlocking' devices sometimes referred to as 'smart' karabiners. There are also category E devices which are generally continuous systems that require little or no manipulation from the participant. If Category B is utilised (Category A is not recommended), then the following points should be considered:

- There is likely to be benefit in ensuring that participants are initially introduced to the problem of 'double unclipping' and associated procedures in a safe setting (such as on the ground). This could be under Level 1 supervision but more likely Level 2.
- There is clear benefit from then progressing to some form of 'practice' course where the risk of injury (even in the event of a fall) is low. A 'low' course that simulates some of the elements of the 'high' course, but is only 1 - 2 metres off the ground, is likely to be advantageous. Participants can demonstrate their competence to handle the clipping and unclipping in comparative safety. This must be under Level 2 supervision (or Level 1 if appropriate, but this would entail an instructor on each platform). EN 15567 requires a minimum of 5 changeovers in this practice section.
- There may be value in using a buddy system with some form of "clip!" - "check!" system, whereby the buddy on the ground confirms the 'clip' before the buddy on the element moves on. In practice, there is observable difficulty in keeping the concentration of the ground buddy sufficiently active for this system to retain its usefulness as an effective preventative measure. Careful tutoring and monitoring by instructors can help, as can personalised initiatives which focus on keeping this important communication effective.
- There may be distractions for the ground buddy. It would be desirable to arrange the course so that there were, for example, no low-level elements to 'play' on instead of concentrating on their buddy.
- There may be advantages to having instructors 'aloft' with the group.
- There are obvious advantages to ensuring that a participant is otherwise secure (in balance, feet secure and both hands free) at the point

of 'clipping' out from one element and into another. This approach of 'safe zones' does not prevent total unclipping; it merely reduces the risk of the person also falling.

- Participants may, understandably, become stressed and confused at height. A general principle of keeping these two emotional states separate seems sensible so that the more stressed a participant is, the more clear it should be as to what they need to do. Below are some examples of how this could be achieved. An essential mechanism for addressing this is to be able to see the course through the eyes of the participant.
  - » Inevitably, there will be many cables, staples, brackets etc., only some of which need concern the participant. It should be very obvious what the user is going to clip to before they unclip. This is an essential requirement of EN 15567. Safety cables should be rigged to avoid, for example, clipping off a low unclip followed by standing up to clip on to a high clip, or 'clipping off' whilst out of sight from what they need to 'clip on' to, or having to stretch (or climb) in order to reach the clip.
  - » As indicated above, there is a very clear requirement in the standard for the safety line on each element to be clearly marked. If the level of supervision is reduced from Level 2 to Level 3, then additional safety notices and markings will be required.

- » There may be benefit in colour coding other parts of the course. For example yellow is what you clip to, red can be used for hands and feet, whilst black is part of the structure and need not concern the participant.
- » Choosing the right karabiner is important. It must have a minimum of a double action capability (captive eye karabiners are generally well suited). Although EN 15567 permits a Category A karabiner it should be remembered that this a European-wide standard, and what is considered acceptable practice in some countries may not be in others. Individual safety system Category B, C, D or E should be adopted.
- Vertical ascent provides a quite different safeguarding problem to traversing elements. Users may find it confusing changing back and forwards between systems. It is likely to be equally confusing if there are intermediate belay points between cables. Vertical sections present a much greater hazard as the risk of a high fall is often present.
- It seems sensible to restrict the activity (or selected elements) to those users who have been judged to have the mental and physical capacity to safely be involved and who are likely to benefit from the exercise.
- It is common practice on commercial courses for accompanying adults to be required to assume responsibility for themselves and for children in their care. See the table below.

### Individual safety systems

Minimum supervision levels 1 to 3 depending on safety categories and the participant's age

		Test Course				First five change-overs <sup>a</sup> after the test course				Rest of the course			
		< 6	6 to 9	10 to 13	from 14	< 6	6 to 9	10 to 13	from 14	< 6	6 to 9	10 to 13	from 14
Category of the individual safety system	A	1	2	2	2	1	2 <sup>b</sup>	2 <sup>b</sup>	2	1	2 <sup>b</sup>	3 <sup>b</sup>	3
	B	1	2	2	2	1	2 <sup>b</sup>	2 <sup>b</sup>	2	1	2 <sup>b</sup>	3 <sup>b</sup>	3
	C	1	2	2	2	1	2	2	2	2 <sup>b</sup>	3 <sup>b</sup>	3	3
	D	1 <sup>c</sup>	2 <sup>c</sup>	2 <sup>c</sup>	2 <sup>c</sup>	2 <sup>b</sup>	2	3	3	3 <sup>b</sup>	3	3	3
	E	1 <sup>c</sup>	2 <sup>c</sup>	2 <sup>c</sup>	2 <sup>c</sup>	-	-	-	-	3 <sup>b</sup>	3	3	3

a For courses using a category D safety system, the first five change-over's may be included within the test course. In this case the supervision levels of the test course apply.  
 b Accompanied by a supervising adult.  
 c If required under 6.3.3.



## 8.25 Selecting competent suppliers

Buying a ropes course and off-ground adventure activities course is a significant financial investment and should not be undertaken lightly. Time spent investigating the right product and supplier is essential. The relationship between supplier and operator is usually long-lived and selecting the right partner is therefore important.

There is also a legal duty placed on operators to ensure that their suppliers are competent. There are some key factors that should be considered when buying an off-ground adventure activities course .

- Ensure that you, as the client, are aware of your duties under **CDM** .
- Consider websites and marketing material claims carefully. Whilst some claims may be genuine, others may be false. However, the ropes course and off-ground adventure activities industry is subject to normal trading standards regulation, so buyers have a variety of rights that are considered 'inalienable' (i.e., the purchaser does not lose these rights even though they may have signed a waiver to that effect). Better, though, to exercise all due diligence in the first instance.
- Do not ask a supplier to volunteer references, but instead request a client list with start and finish dates of each project. Consider establishing, from the client, the following:
  - » Was the course built on time?
  - » Was the course built to budget?
  - » Did the construction process and the finished product fulfil the operators expectations?
  - » Were the trainers certified by ERCA or at the very least can they provide you with evidence of ropes course and off-ground adventure activities experience? The latter should not only be in a 'technical expert' capacity but actually working with users / groups on an off-ground adventure activities course. There is no substitute for real experience.
  - » Was the training good?
  - » Did the ropes course and off-ground adventure activities course pass an inaugural inspection in accordance with EN 15567?



- » Who carried out the inspection? In particular, was the Inspection Body competent and independent?
- » Was the after-sales service good?
- » Would they employ the contractor again for future work or would they look elsewhere?
- Ask your prospective supplier if you can visit similar installations to the one you are considering buying.
- Ask to see a copy of a supplier's Public Liability Insurance Certificate (and if relevant Contract Works, Product Design insurance etc.). Check that the policies are genuine.
- Request a copy of relevant certificates, including but not limited to:
  - » chainsaw operators
  - » first aid certificate
  - » MEWP (Mobile Elevating Work Platforms - cherry picker) and other plant operator licences
  - » LOLER (lifting certificates) for lifting equipment (hoists etc.)

If in doubt, check with the issuing body of the above certificates to confirm the certificates are genuine.

- Pay little regard to claims of guarantees. Whilst subsequent redress through the courts may be possible, the process is inevitably slow, expensive and highly inconvenient. Ask to speak to previous clients. It is easy to offer guarantees but harder to deliver!
- Remember all installations should have design calculations and engineers' drawings.
- Don't underestimate the cost. Always have a contingency.
- Ensure that suitable terms and conditions within the contract are in place to rectify defects.
- Are contractors appropriately trained and experienced to work at height? What evidence do you have?

Whilst it may seem strange and even unfair, operators have considerable responsibilities for ensuring that the contractors they engage are competent. If, for example, the contractor has an accident during construction, operators should anticipate having to prove their due diligence in ensuring the contractor's competence.

- Does the proposed design address the WAHR in terms of instructors accessing the off-ground adventure activities for inspection or maintenance purposes?
- Ensure CDM regulations are complied with, including **client duties** . All construction is covered under CDM, some parts of which are also notifiable to the HSE.



The same due diligence should be applied to selecting appropriate Inspection and Training Bodies.

An inaugural inspection will ensure that you meet the requirements of EN 15567. The standard recommends that a Type A Inspection Body (as defined by ISO 17020) carries this out. Ensure the Type A Inspection Body really has extensive off-ground adventure activities experience.



















Thereafter, take care to ensure periodical inspections are carried out by a Type A, B or C Inspection Body that has sufficient competence and integrity.

## 9 References and further reading

For further information about this guidance or for general off-ground adventure activities related matters please contact either:

- **AAIAC** <https://www.aaiac.org/> 
- **ERCA** <https://www.erca.uk/> 

There are a variety of sources of information available for operators of off-ground adventure activities. This is not an exhaustive list but are primary references.

- **Health and Safety at Work etc. Act 1974** 
- **Adventure Activities Licensing Regulations 2004** 
- **Lifting Operations and Lifting Equipment Regulations, 1998** 
- **The Health and Safety (First-Aid) Regulations 1981** (amended 2013) 
- **The Personal Protective Equipment at Work Regulations 1992** 
- **The Provision and Use of Work Equipment Regulations 1998** 
- **The Management of Health and Safety at Work Regulations 1999** 
- **The Construction (Design and Management) Regulations 2015** 
- **The Reporting of Injuries, Diseases and Dangerous Occurrences Regulations 2013** 
- **Work at Height Regulations, 2005** (as amended 2007) 
- **HSG 175 Fairgrounds and amusement parks: Guidance on Safe Practice** 
- **HSG48 - Reducing Error & Influencing Behaviour (HSG48, 1999)** 
- **HSG 65 Managing for health and safety** 
- **EN 15567-1:2015+A1:2020 and EN 15567-2:2015** 
- **BS EN ISO/IEC 17020:2012 Conformity assessment. Requirements for the operation of various types of bodies performing inspection** 
- **BS EN 17109:2020 Mountaineering equipment. Individual safety systems for rope courses. Safety requirements and test methods** 
- **BS EN 1176-7:2020 Playground equipment and surfacing. Guidance on installation, inspection, maintenance and operation** 
- The UK Ropes Course and Off-Ground Adventure Activities Guide, 2021 (this document)
- **European Ropes Course Association Standards** (member only access) 





## Appendix A 16th February (revised 2020) Statement by the Adventure Activities Licensing Authority in relation to Licensed establishments using ropes courses

Ropes courses are out of scope of the Adventure Activities Licensing Regulations, so providers of high or low ropes courses do not require a licence for this activity. However, if licensable activities are also being offered at a centre, the Licensing Authority will take a holistic approach when considering safety management systems. This means that inspectors may ask about the management of health and safety in relation to non-licensable activities as an indicator of the culture of safety overall.

The information obtained in relation to non-licensable activities will inform the inspector's decision, however if a licence is declined because of concerns about a provider's ability to manage safety effectively, this will not prevent you from providing non-licensable activities. Notwithstanding that, concerns about safety may indicate a breach of the Health and Safety at Work etc Act 1974, or associated Regulations and AALA inspectors are obliged to report such concerns to the relevant enforcing authority.

Ropes courses are currently out of the scope of the Adventure Activities Licensing Regulations, and so providers of high or low ropes courses do not

## Appendix B Procedures for submitting comments on this guidance

Comments should be addressed by email or post to either AAIAC or ERCA

Please ensure that comments:

- Are typed or emailed
- Include the name and contact details of the person making the submission
- Include the date of submission



## Photo credits

AAIAC and ERCA would like to thank the following for the use of photographs in this guidance.

Funchal	Front Cover, Pages 14 and 16
Go Ape	Pages 5, 20, 22, 27, 33 and 40
Rockley Adventure (Buddens)	Front Cover, Pages 39 and 43
Zip World	Pages 4, 7, 22, 36 and 48
JM Adventure	Pages 11, 24 and 41
Mojo Active	Pages 12 and 34
Vertex	Pages 17, 20, 21, 24, 25, 29 and 38
PGL	Page 17
DMM Wales	Page 18
C.A.M.P. USA Inc	Page 18
Petzl	Page 19
ISC Ltd	Page 19
Edlerid	Page 19
CLiC-iT®	Page 19
On-the-ropes (Roperoller®)	Page 19
Kanopeo (Saferoller®)	Page 19
Kanopeo	Page 25
Niko Ltd	Page 19
Ropes Course Inc.	Page 19
COUDOU PRO	Page 19
RockReef, Bournemouth Pier	Page 21
7x19 Consultancy Ltd	Pages 26, 30 and 31
Technical Outdoor Solutions	Page 32
Surrey Outdoor Learning and Development	Page 42

## Thanks

We would like to extend our thanks to the following people for their support and advice:

- AAIAC Committee
- ERCA Executive Board
- ERCA UK Board Members
- James Jevon - DWF Group
- John Ruddock - ADIPS
- Meik Haselbach – ERCA
- Frances Kelly - HSE
- Sue Kashanski

## Publisher and Copyright

AAIAC is the publisher and copyright holder of this document and the contents may not be copied without permission.

**Adventure Activities Industry  
Advisory Committee**  
[www.aaiac.org](http://www.aaiac.org)

Image copyright is owned by the person and/or company and must not be copied or distributed in any way without prior permission.

